

# DPRO 6 HD

---

## User's manual



---

<b>Author</b>	A.Tomassini
<b>Version</b>	3.2.3 - 10/12/2024
<b>Copyright</b>	© 2024 ITEL Elettronica e Telecomunicazioni Snc

# Table of contents

<b>Section 1 Description</b>	<b>5</b>
1 List of changes .....	5
2 Warnings .....	5
3 Front panel .....	6
4 Rear panel .....	6
5 Editing and navigation .....	6
<b>Section 2 Front panel display</b>	<b>10</b>
1 Audio processor .....	10
AGC .....	10
Compression levels .....	10
Multiband limiter parameters .....	11
Multiband limiter thresholds .....	11
Bass parametric eq .....	11
Bass clipper/limiter .....	12
Loading a preset .....	12
Saving a preset .....	13
Bypass .....	13
2 Audio input setup .....	14
Audio levels monitor and input level setting .....	14
Audio source setup .....	14
Audio processor preset selection .....	15
Audio fallback setup (audio backup) .....	15
3 Audio output setup .....	16
Audio output regulation .....	16
Loudness limiter .....	16
4 System setup .....	17
Display, Source Dependent Presets, Device ID .....	17
GPI .....	17
PassCode Setup .....	19
Ethernet setup .....	19
System info .....	19
Options .....	20
Login window .....	20
5 Headphones Level .....	21
<b>Section 3 Programmimg software</b>	<b>23</b>
1 Main window .....	23
2 Processor Params .....	24
Processor Presets .....	24
AGC .....	26
Multiband .....	27
Bass EQ .....	28
Audio input-output .....	29

---

System setup .....	30
Loudness limiter .....	31
<b>3 Loading and saving a preset .....</b>	<b>32</b>
<b>4 Loading and saving system .....</b>	<b>33</b>
<b>5 Passcode setup .....</b>	<b>34</b>
<b>Section 4 Streaming audio module</b>	<b>36</b>
<b>1 Decoder audio Stream .....</b>	<b>36</b>
Status .....	37
Streaming settings .....	41
Network settings .....	42
System settings .....	44
System update .....	45
Finder software .....	46
<b>2 Encoder audio Sream .....</b>	<b>47</b>
<b>3 Quick setup .....</b>	<b>47</b>

# Section

---

Description

# 1

# 1 Description

This product is a fully multiband digital audio processor ideal for general Dtv and multimedia applications optimized for DAB+ and HD Radio broadcasting.

All audio processing is realized using DSPs, allowing for stable performance over time and extending functionality with firmware upgrades.

The audio processing chain comprises a two bands AGC which feeds the six bands limiter-compressor, followed by a final clipper-limiter operating at 96KHz, optimized for distortion masking, thus obtaining a cleaner and clipping artifacts free sound.

## 1.1 List of changes

1.0.0.0	28/07/2015	first release
1.1.0.0	10/09/2015	updated to new firmware 3.0 features
1.2.0.0	13/01/2016	updated to new firmware 3.1 features
3.2.0.0	14/09/2016	updated to new firmware 3.2 features
3.2.1.0	08/03/2021	updated to new firmware 3.2.1 features

## 1.2 Warnings



**Before attempting any operation, please follow the safety instructions contained in the following paragraph.**

**The producer declines any liability for damage to people or things due to non-compliance, even if partial, of the following indications**

- Ensure that the supply voltage corresponds to what is indicated on the apparatus.
- Ensure that the electrical system is equipped with a ground connection.
- Use only power sockets and cables with ground connection
- Disconnect power before attempting any operation inside the device.
- The power cutting device is the power cord, so this should be easily accessible and the socket must be positioned close to the apparatus.
- Any operation involving the access to internal parts must be performed only by trained service personnel.

## 1.3 Front panel

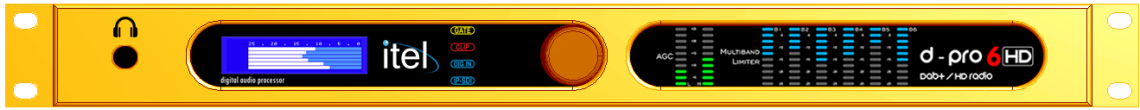

### Front panel indicators and rotary knob

Headphone stereo jack 6,3mm (1/4")

- GATE: led is on when level is below gate threshold
- CLIP: the analog input level is too high.
- DIG IN: AES/EBU digital input is selected as audio source
- IP-SDI: Network IP is selected as audio source as audio input.
  
- AGC: input AGC gain level
- MULTIBAND LIMITER: multiband limiter compression level

Menus navigation and parameter editing is done through the rotary knob.

## 1.4 Rear panel

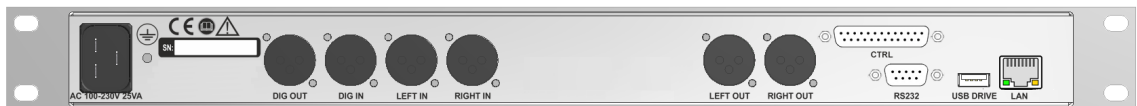

### Connectors on rear panel

- DIG OUT (XLR M) AES/EBU output
- DIG IN (XLR F) AES/EBU input
- LEFT IN (XLR F) Left analog input
- RIGHT IN (XLR F) Right analog input
- LEFT OUT (XLR M) Left channel analog output
- RIGHT OUT (XLR M) Right channel analog output
- CTRL (DSUB 25F) Control port (option)
- RS232 (DSUB 9F) RS232 connector
- USB DRIVE (USB-A) USB connector for fallback audio on external drive (option only with ip audio decoder)
- LAN (RJ45) LAN connector for remote control or streaming audio module (option)

## 1.5 Editing and navigation

Menu navigation and parameters editing is done by the front panel knob.

On the main menu which appears after firmware boot, is possible to select the submenu for the various settings.

```
DPRO
Audio Input <
ID:STATION NAME
```

Pressing the knob, will enter the selected submenu.



Once entered in the desired sub-menu, if there are adjustable parameters, you can proceed to editing

```
Set Input:Digital
Analog lev: 0 dB
Dig. lev: 0.0 dB
Net lev: 0.0 dB
```

Pressing the knob, an asterisk "\*" will appear next to the first editable element. This will not happen if, on the current window, there are no editable parameters.

```
Set Input:Digital *
Analog lev: 0 dB
Dig. lev: 0.0 dB
Net lev: 0.0 dB
```

Turn the knob to position the "\*" cursor on the other editable elements of the current window.

```
Set Input:Digital
Analog lev: 0 * dB
Dig. lev: 0.0 dB
Net lev: 0.0 dB
```

If you want now to change the analog input sensitivity, press the knob again. A "<" symbol will appear next to the parameter to indicate that this is being edited.

```
Set Input:Digital
Analog lev: 0 < dB
Dig. lev: 0.0 dB
Net lev: 0.0 dB
```

Turning the knob, you now will modify the selected parameter's value.

```

Set      Input:Digital
Analog  lev: -6 < dB
Dig.    lev:  0.0 dB
Net     lev:  0.0 dB

```

Once set the desired value, press the knob again. The cursor will switch to "\*" again, indicating that items navigation mode is now active and other items can be selected and edited as described before.

```

Set      Input:Digital
Analog  lev: -6 * dB
Dig.    lev:  0.0 dB
Net     lev:  0.0 dB

```

If editing is however terminated, press the knob again and the "\*" cursor will disappear and you can rotate the knob to navigate to other windows.

```

Set      Input:Digital
Analog  lev: -6  dB
Dig.    lev:  0.0 dB
Net     lev:  0.0 dB

```

Inside any submenu, pressing the knob for more than 3 seconds, will cause a jump to the main menu.

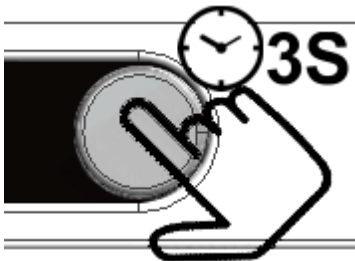

```

DPRO
Audio Input  <
ID:STATION NAME

```

When pressing the knob for 1 seconds, will appear the [Headphone Level](#) regulation.

# Section

---

Front panel display

# 2

## 2 Front panel display

Following are listed all menus and functionalities available on the current firmware release.

### 2.1 Audio processor



Into this section are comprised all functions and menus related to the audio processor.

#### 2.1.1 AGC

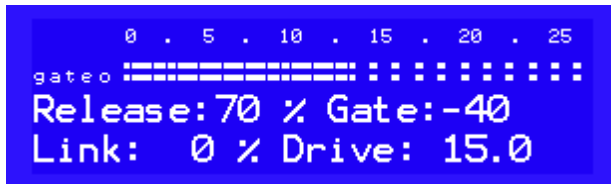

This window contains the settings for the dual band automatic gain control (AGC) block, placed at the head of audio processing chain.

The automatic gain control performs a pre-leveling of the signal applied to the following compressors/limiters, keeping their working point almost constant.

At the right side of the bar which indicates the level of pre-amplification applied to the input signal, is placed the AGC status indicator: if "gate" indication is off, the input level is above the gate threshold and the AGC and compressors/limiters are operating correctly, if "gate" indication is on, it means that the input signal is below the minimum level so the AGC release is slowed down and the AGC will slowly raise its gain.

**Release (...):** AGC release time setting (40% fastest, 200% slowest).

**Gate:** Gate level setting. Below this level, the AGC and multiband limiter release is slowed down.

**Link:** set the maximum compression difference between the bass and middle/highs band.

Setting this value to zero, the bass compression level will be totally independent and this will cause also a mild auto-equalization.

Setting this value to 100%, it will force the bass compressor to have a gain never greater than the middle/highs band giving a sound very close to the original.

**Drive:** indicates the AGC input driving level, thus determining the AGC maximum gain .

#### 2.1.2 Compression levels

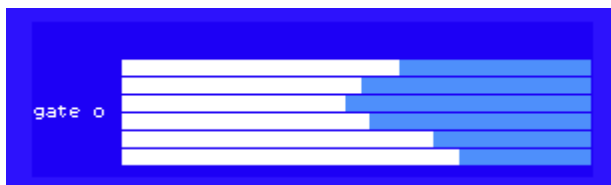

In the window, the gate status and compression-limiting levels of the multiband limiters are shown.

### 2.1.3 Multiband limiter parameters

```
MbDrive: 10 dB
Release: 120 %
FinalClip Drive: 2.0 dB
Denoise: OFF Brill: 50%
```

**MbDrive:** multiband limiter drive level.

**Release:** Multiband limiter release time.

**FinalClip Drive:** set the wideband final clipper driving level. Higher driving level corresponds to higher loudness, but will cause higher distortion.

**Denoise:** Denoiser. If activated, it will monitor the high frequency content of the audio input signal, reducing the band 6 gain when HF input level is too low. It can be used to reduce noise coming from old tape recordings.

**Brill:** Brilliance high band (>6KHz) shelf equalizer, increasing the value produces an increase in the high frequencies.

### 2.1.4 Multiband limiter thresholds

```
Multiband thresholds
B1: 2.0 dB B2: -3.0 dB
B3: -2.0 dB B4: 0.0 dB
B5: 0.0 dB B6: 0.0 dB
```

All six-bands limiters thresholds are adjustable in order to apply a dynamic equalization according to the user's taste. Lowering the limiting threshold of any band will result in attenuating the level of that band, while raising the threshold, will amplify its level.

The six bands cutoff frequencies are :

B1: 100Hz and below

B2: 400Hz center frequency

B3: 800Hz center frequency

B4: 1600Hz center frequency

B5: 3200Hz center frequency

B6: 6400Hz and above

### 2.1.5 Bass parametric eq

```
BassEqFreq: 80 Hz
BassEqGain: 6.0 dB
BassEq Q: 0.70
Punch Enh : 2
```

**BassEqFreq:** parametric equalizer center frequency

**BassEqGain:** gain (boost) of parametric equalizer.

**BassEq Q:** Q-factor (bandwidth) of parametric equalizer.

**Punch enh (0..2):** punch enhancer (0 off, 2 max). Give some nice "analog-style" bass enhancing.

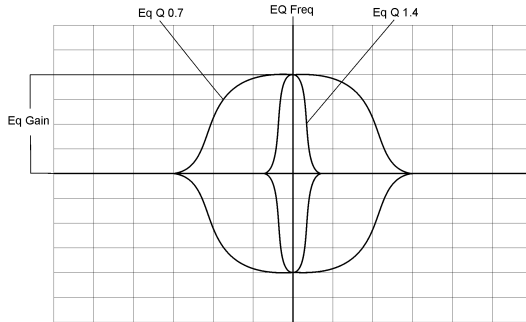

### 2.1.6 Bass clipper/limiter

```
Bass Clip Thr: - 1.0 dB
Bass Clip Softness: 8
Input HPF :ON
```

**Bass clip Thr:** bass clipper threshold.

**Bass clip softness:** bass clipper curve selection.

Bass clipper will have a curve progressively softer with increasing value.

A softer curve reduces the distortion introduced by the clipping in contrast, setting to zero (corresponding to the hardest curve), will produce a bass rich in harmonics.

**Input HPF (ON/OFF):** enables / disables the 30Hz high pass filter for infrasonic component reduction.

### 2.1.7 Loading a preset

```
AIR MOD MUSIC HOT
TRY F08 SPEECH OPN

COMPARE EXIT
```

The "AIR" field shows the on-air preset name, while, in the "TRY" field, can be specified the name of a new preset to load. Once selected the desired preset, go on the "COMPARE" label which will start to flash.

When "COMPARE" is flashing, pressing the front panel knob will cause the "TRY" preset to go on-air while the previously on-air preset will go to "TRY", allowing for comparison.

If [Source Dep.Presets](#) function was enabled, it will be possible to specify a different preset for each [audio source](#) selected so, in this case, the source for which the current preset is used will be displayed.

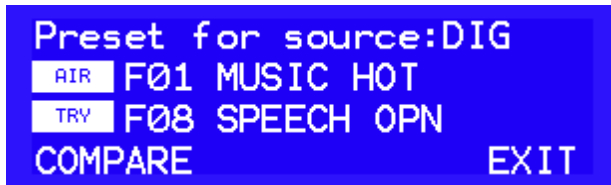

It is possible to change the audio source from [Audio Input](#) menu.

If necessary, make any editing you want to the factory preset (any preset starting with Fxx) selected, then save the preset to a user memory (Uxx).

Once saved, the preset will become the audio processing preset for the selected audio source, or the general preset used for all sources, depending on whether or not the function "Source Dep.Presets" was enabled.

A modified, but not saved, preset will be marked by the "MOD" prefix. This preset will be overwritten if a new preset is loaded and then edited.

*Mode F00: BYPASS, has the input level as the only editable parameter and this is the same both for the Analog / AES EBU source and NetAudio.*

*In the case where it is necessary to put have the processor in bypass mode when any of the two sources are selected, it will be possible to compensate the differences in audio levels, if any, adjusting their input levels from the audio input menu.*

*If one of the sources is the Analog channel, we recommend to set the input level of the AD converter in coarse 6dB steps, then use the bypass input level for fine tuning of Analog source, then adjusting the level of the other channel, netaudio or AES EBU, from the audio input menu*

### 2.1.8 Saving a preset

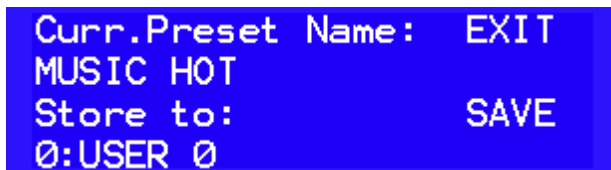

Curr Preset name shows the name of the preset which is actually on air. The name can be changed following the editing rules described before. When name editing is finished, the "\*" cursor will be positioned to the right side of the name string and will allow to move on the other editable elements on the window.

Once the preset name has been edited, you can choose a user file to store it, then go to "SAVE" button which will start to flash. Pressing now the knob will result in saving the preset to the specified user file.

### 2.1.9 Bypass

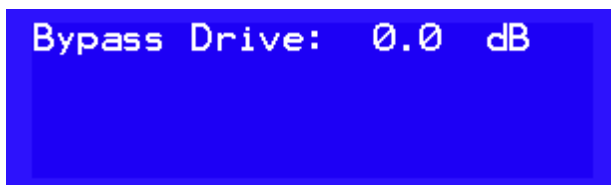

If the selected process is "F00: BYPASS", the only editable parameter will be the input level. No other parameter is used, so the other editing windows will be hidden.

## 2.2 Audio input setup

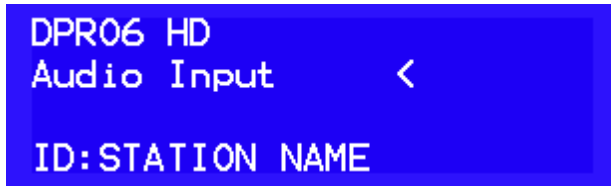

In this section are present all controls related to audio sources and [automatic audio fallback](#)

### 2.2.1 Audio levels monitor and input level setting



In the current window is displayed, with greater accuracy, the input level of the selected channel.

*The input level of the selected channel can be adjusted, but the channel will not be put on air. To change the on air input channel, the following window must be used.*

### 2.2.2 Audio source setup

**Audio input:** Analog, analog input  
Digital, AES/EBU input  
NetAudio, streaming audio input.

**Analog lev:** audio input attenuator level. This adjustment sets the input level to the A / D converter. The nominal level is indicated in the bars:

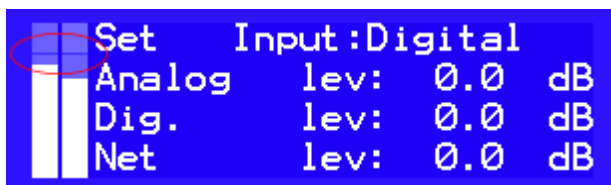

The initial adjustment of the input level should be made so that the maximum analog input level is equal to or only slightly above that limit.

*In no case the front panel "CLIP" led should light.*

**Dig. lev:** AES/EBU level adjustment

**Net lev:** streaming module level adjustment.

The adjustment of the individual channels is in 0.1dB steps.

### 2.2.3 Audio processor preset selection

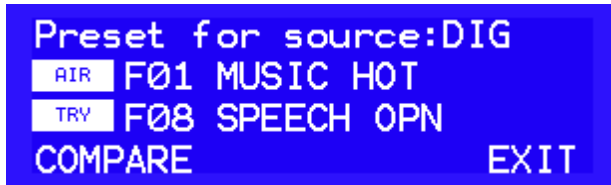

If [Source Dep.Presets](#) function was enabled, it will be possible to choose a different preset for each audio source, which can be selected in the previous menu, otherwise this window will not be visible. Once selected a preset, it can then be edit into the Audio Processor section.

*The loaded preset will be assigned to the audio source currently on air.*

### 2.2.4 Audio fallback setup (audio backup)

The processor can be set to automatically switch to an auxiliary input source if the main input audio level is below a minimum threshold.

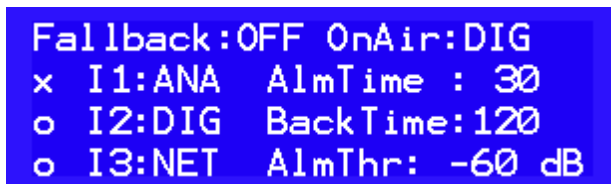

**Fallback (ON/OFF):** Enable / Disable automatic audio fallback on backup source.

**OnAir:** audio source actually on air

**I1 - I2 - I3:** Channel list. The channel are listed by order of priority, with maximum priority assigned to channel 1.

When an high priority channel will become unavailable, it will be replaced by a lower priority one until its recovery.

**AlmTime:** Alarm timeout

**Back Time:** Back timeout. It is the time for which the main audio source must be above the minimum threshold before it can be set back on air.

**AlmThr:** minimum audio level threshold

The main audio source is considered valid If the level of both channels L / R are above the alarm threshold. If a single channel is less than the alarm threshold for a period longer than the alarm timeout, the backup source will be put on air.

When the main audio source will recover, once elapsed the "Back Timeout", it will be put back on air.

*Changes will be applied upon exiting the menu.*

## 2.3 Audio output setup

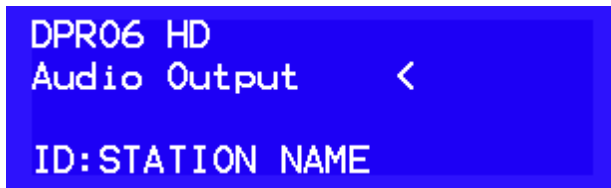

This section contains the settings relating to the DIG OUT - L R OUT audio outputs.

### 2.3.1 Audio output regulation

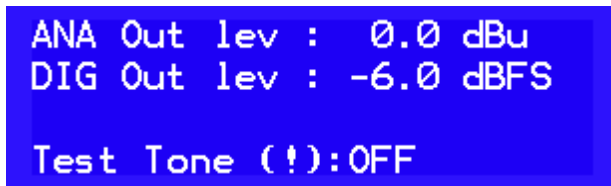

**ANA LR Out** : audio output level on rear XLR Left-Right OUT connector.

**DIG LR Out** : output audio level on rear XLR DIG OUT connector

**Test tone (!)**: when activated, will put on air in all outputs a 400Hz tone 0dBFS.

### 2.3.2 Loudness limiter

The loudness limiter can equalize the perceived loudness among different audio program sources such as live shows, commercials, films, music videos. It operates according to the ITU-R BS1770 standard.



**Itu1770 limiter (ON/OFF)**: enable / disable loudness control.

**Reference**: loudness limiter reference setting

**dblim**: level of limiting applied

*Reference level is referred to an output level of 0dB. Other SDI, Analog, or AES/EBU Output level settings will be added to the reference value set.*

*Eg: SDI output level = 0.0dB, Loudness Reference = -23dB LKFS, results in 0.0 -23 = -23dB LKFS on air*

*SDI output level = -10.0 dB, Loudness Reference = -23dB LKFS, result in -10 -23 = -33dB LKFS on air*

## 2.4 System setup

```
DPR06 HD
System <
ID:STATION NAME
```

### 2.4.1 Display, Source Dependent Presets, Device ID

```
Contrast: 16
Source Dep.Presets:OFF
ID:STATION NAME
```

**Contrast:** display contrast adjustment.

**Source Dep.Presets:** enable/disable audio preset selection depending on audio source.

ON: if the function is enabled, a different audio processing preset can be specified for each audio source.

OFF:if the function is disabled, the same preset will be used for all audio sources.

**ID:** device identifier. It is a 16 characters long label which will be shown in the main menu screen, useful for identification when multiple devices are installed.

### 2.4.2 GPI

```
76543210
GPI status : 00000000
Split ctrl port:OFF
Invert split status:OFF
```

In this menu it is possible to remotely select the channel to be broadcast (optional). Selection is possible via GPI, serial and Network card.

**GPI status:** status of the 8 available ports, from 7 to 0.

**Split ctrl port:** enable the function and select the communication mode.

OFF: disabled function.

GPI: active function on CTRL port.

Serial: active function on RS-232 port.

Network: active function on Ethernet port.

**Invert split status:** only in FM versions

#### Rear Connectro GPI (CTRL)

**GPI port status:**

- 0: Pin 6 - Set ANALOG Input
- 1: Pin 2 - Set DIGITAL Input
- 2: Pin 7 - Set NET/IP Input
- 3: Pin 3 - Not used
- 4: Pin 8 - Not used
- 5: Pin 4 - Not used
- 6: Pin 9 - Not used
- 7: Pin 5 - Not used

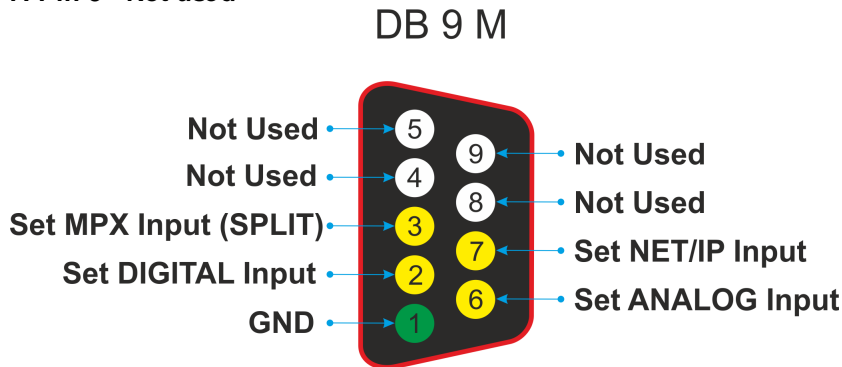

The inputs are activated by grounding the relative pin or by providing a voltage from 5 to 12VDC, in this case the jumpers placed on the board inside the device will have to be moved from the "CLOSE" to "VIN" position.

The selection of the channels through the GPI port takes place with exclusive priority on a single channel, if more inputs are activated at the same time the channel is restored before the selection

Example: the Analog channel is on the air, pin 2 is activated by broadcasting the Digital channel, at the same time pin 7 NET / IP is also activated, since the selection of two channels is not valid at the same time, the Analog channel returns to air .

Network commands from Lan network:

By selecting Network on "Split ctrl port" commands can be sent via LAN using the UDP protocol with standard ethernet card, the TCP protocol with IP Streaming option card.

#### Network commans by Lan:

By selecting Network on "Split ctrl port" commands can be sent via LAN using the UDP protocol with standard ethernet card, the TCP protocol with IP Streaming option card.

```
[AB010103] select analog input
[AB010200] select digital input
[AB010301] select NET/IP input
[AB010002] o [AA010100] return on main channel
```

The selection command must be repeated continuously otherwise the device re-enters the main channel.

### 2.4.3 PassCode Setup

```
User Password:      0000
Autologout (mins):  3
LOGOUT              SAVE
```

**User Password:** in this section the user can enter a numeric password that will be required for accessing the device. Setting "0000" (default value) will disable the password prompt.

**Autologout (mins):** Automatic lock timeout. If no action is done on the front panel knob within the specified time interval, the device will enter into lock state and the user will need to re-enter the password to log in again.

**LOGOUT:** immediate logout and lock.

**SAVE:** Saves any changes made to the numeric password or the duration of the automatic logout timing.

### 2.4.4 Ethernet setup

```
IP : 192 168   1  50
GWY:   0   0   0   0
Port : 54000
Net Mask : 24          APPLY
```

**IP:** current ip address

**GWY:** gateway address

**Port:** UDP port number

**NetMask:** netmask in CIDR notation.

**APPLY:** apply and save changes.

*This page is visible only if the network module is installed.*

### 2.4.5 System info

```
itel Sys : X.X.X.X
      Proc: X.X.X.X
      Hw  :XX BL:XX
1234567890123456789012345678-XX
```

**Sys:** operating firmware release

**Proc:** audio processor coder firmware release

**Hw:** hardware release

**BL:** MCU bootloader release

**SN:** serial number

## 2.4.6 Options

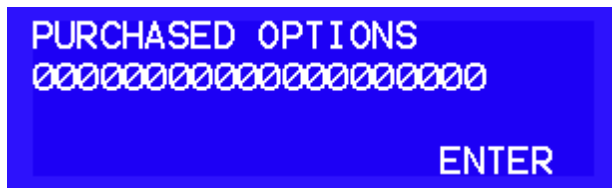

In this window the user must enter the code to enable the optional features.

Once entered the code for the desired option, go to the "ENTER" button and, when it will flash, push the front panel encoder.

The device will verify the code and, if found correct, will activate the requested option.

## 2.4.7 Login window

To protect the device from unauthorized operation, a security code can be enabled by accessing the System menu, [Set password](#).

When the device is turned on (or the auto logout time is elapsed), the login page will be shown where the pass code is to be entered.

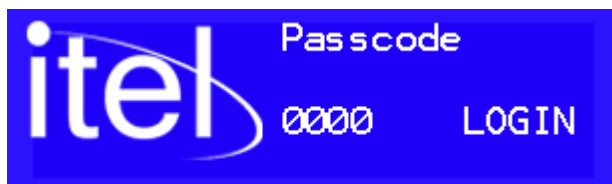

**LOGIN:** when the correct pass code is entered, will log in user.

**Pass code lost or forgotten:** after the 20th unsuccessful login attempt, an unlock code will be displayed. Call customer service and tell this code in order to get back your pass code.



## 2.5 Headphones Level

The headphone level can be adjusted using the front panel knob. Pressing the knob for more than 1 second, will show the adjustment level menu.

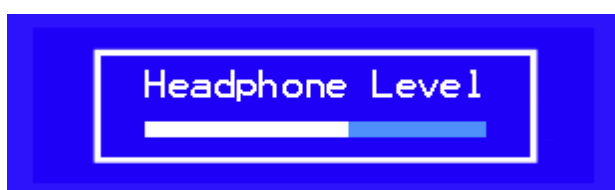
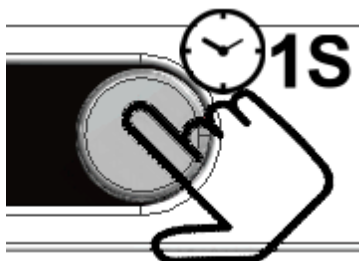

After 3 seconds the level menu will close automatically.

# Section

---

Programming software

# 3

## 3 Programming software

A PC based software Multiband Processor Programmer, compatible with 32 and 64 bits Windows Xp, Windows 7, Windows 8.X, Windows 10, is provided for processor remote control and setup.

Connection is done through:

- serial port 9600 baud 8N1
- ethernet port TCP-IP (if optional streaming module is installed)
- ethernet port UDP

### 3.1 Main window

In the main window the type of connection can be selected, via COM port or through Ethernet port using TCP-IP (needs streaming module) or UDP (needs ethernet module). Once the communication mode is set up and the processor connected, press "Connect". If communication is correct, the program will read all internal settings and device information.

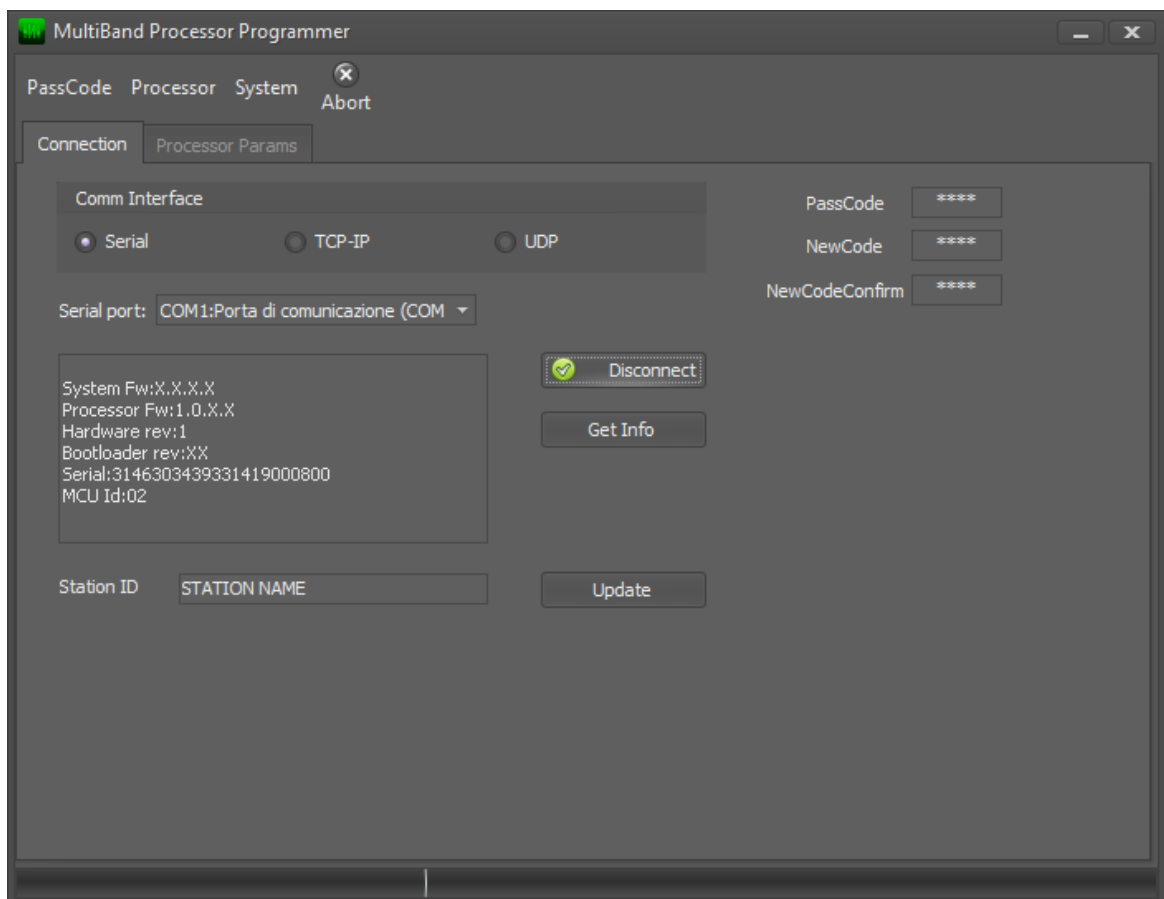

## 3.2 Processor Params

This section contains the audio process controls and presets, setting of the audio input and output sources and system parameters.

### 3.2.1 Processor Presets

On this page are shown the input levels, the audio input currently on air, the presets list and the audio processing parameters.

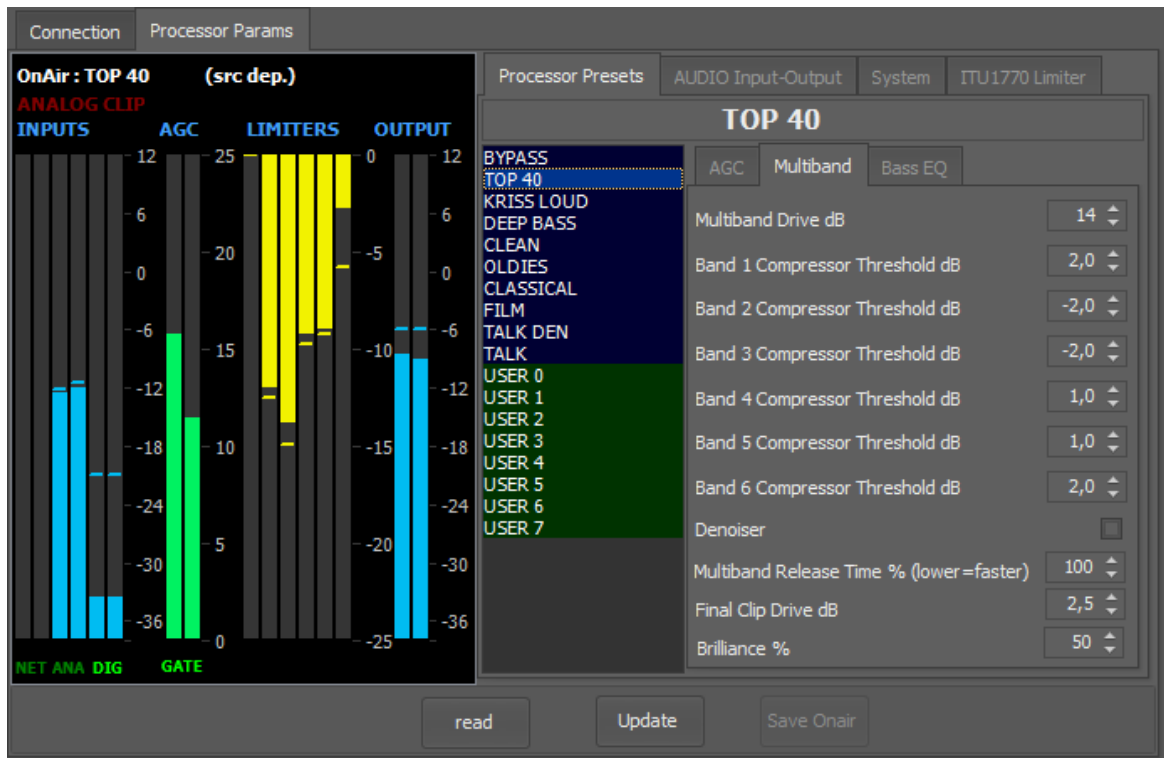

All presets are listed and, with a double click, is possible to recall a preset and put it on air. Factory presets are displayed in blue background, user definable presets in green and, in orange, a modified preset not yet saved.

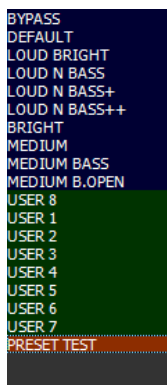

*The modified preset (in orange) will be usable until a new preset is loaded and then modified.*

On the same page are present the audio processing parameters. For a detailed description of each parameter, please refer to the [audio processor](#) section:

**Processor Drive, Gate Level**

[AGC Enabled, AGC Speed](#)

**Compression, Master Release**

**Band Link, Brilliance, Presence**

[Bass Lim Thr, Bass Lim Presence, Bass Clip Threshold, Bass Clip Softness](#)

[Bass EQ, Bass EQ Q, Bass EQ Freq](#)

**Expander Level, Stereo Expander Enabled**

**Read:** read the parameters setup from the processor

**Update:** send the modified audio processing parameters to the processor: when a factory or a user preset is modified, a temporary preset will be created. The **Save Onair** button will be enabled to save the preset once changes are terminated. The preset name can be directly changed in the preset name editor.

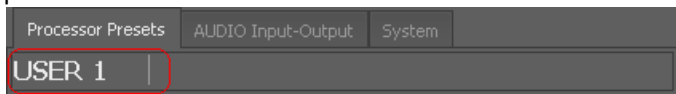

Then, pressing the **Save OnAir** button, it will be possible to select the destination user preset.

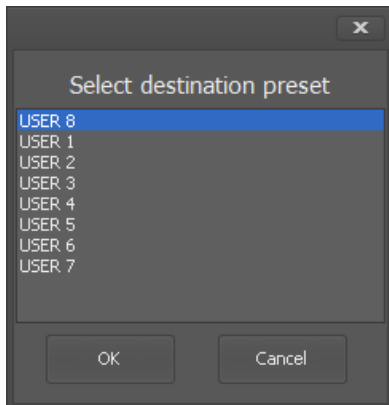

### 3.2.1.1 AGC

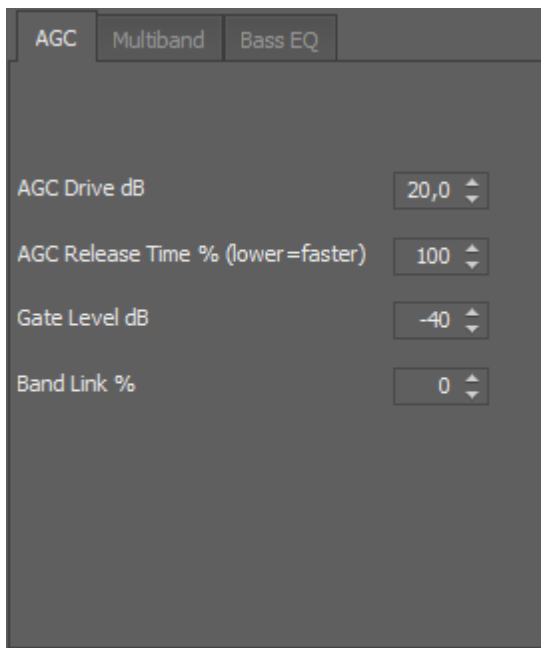

This window contains the settings for the dual band automatic gain control (AGC) block, placed at the head of audio processing chain.

The automatic gain control performs a pre-leveling of the signal applied to the following compressors/limiters, keeping their working point almost constant.

At the right side of the bar which indicates the level of pre-amplification applied to the input signal, is placed the AGC status indicator: if "gate" indication is off, the input level is above the gate threshold and the AGC and compressors/limiters are operating correctly, if "gate" indication is on, it means that the input signal is below the minimum level so the AGC release is slowed down and the AGC will slowly raise its gain.

**AGC Drive:** indicates the AGC input driving level, thus determining the AGC maximum gain .

**AGC Release Time:** AGC release time setting between 40% fastest and 200% slowest.

**Gate Level dB:** Gate level setting. Below this level, the AGC and multiband limiter release is slowed down, the signal below this threshold it is no longer considered processable.

**Band Link %:** set the maximum compression difference between the bass and middle/highs band, increasing this value the two band link together.

Setting this value to zero, the bass compression level will be totally independent and this will cause also a mild auto-equalization.

Setting this value to 100%, it will force the bass compressor to have a gain never greater than the middle/highs band giving a sound very close to the original.

### 3.2.1.2 Multiband

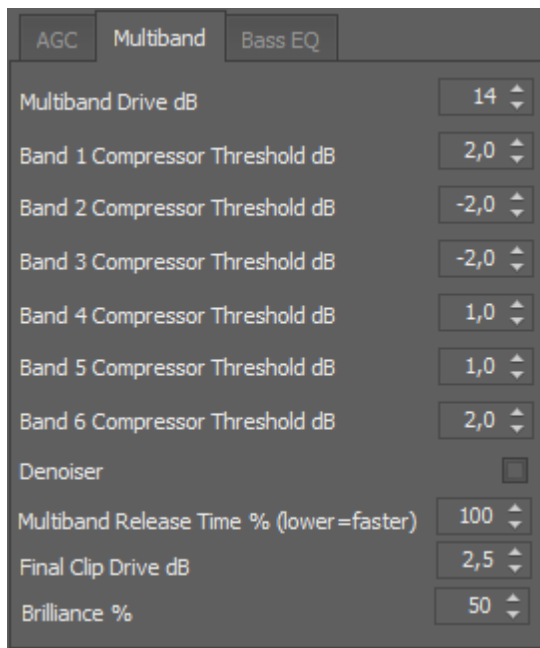

All six-bands limiters thresholds are adjustable in order to apply a dynamic equalization according to the user's taste. Lowering the limiting threshold of any band will result in attenuating the level of that band, while raising the threshold, will amplify its level.

**Multiband Drive dB:** indicates the multiband limiter driving level, thus determines how much the multibands will work and so re-equalize the program.

The six bands cutoff frequencies are :

**Band 1 Compressor Threshold dB:** 100Hz and below

**Band 2 Compressor Threshold dB:** 400Hz center frequency

**Band 3 Compressor Threshold dB:** 800Hz center frequency

**Band 4 Compressor Threshold dB:** 1600Hz center frequency

**Band 5 Compressor Threshold dB:** 3200Hz center frequency

**Band 6 Compressor Threshold dB:** 6400Hz and above

**Denoise:** Denoiser. If activated, it will monitor the high frequency content of the audio input signal, reducing the band 6 gain when HF input level is too low. It can be used to reduce noise coming from old tape recordings.

**Multiband Release Time %:** Multiband release time setting between 40% fastest and 200% slowest, making the multiband faster increases the loudness.

**FinalClip Drive dB:** set the wideband final clipper driving level. Higher driving level corresponds to higher loudness, but will cause higher distortion.

**Brilliance:** Brilliance high band (>6KHz) shelf equalizer, increasing the value produces an increase in the high frequencies.

### 3.2.1.3 Bass EQ

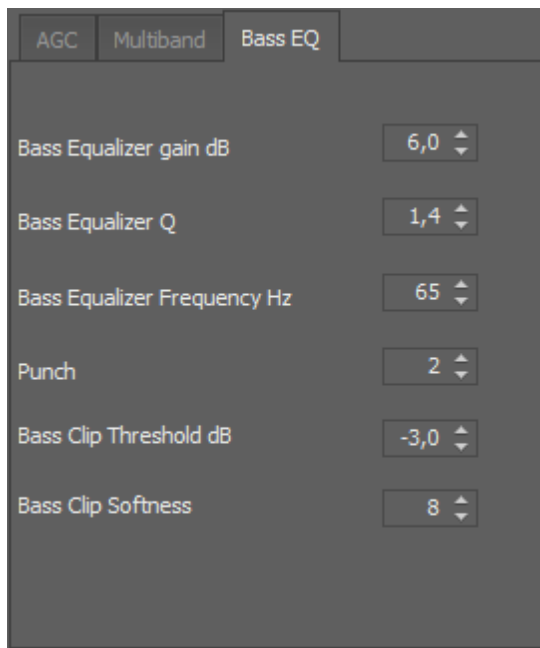

**Bass Equalizer gain dB:** gain (boost) of parametric equalizer.

**Bass Equalizer Q:** Q-factor (bandwidth) of parametric equalizer, increasing this value the filter becomes more selective around the center frequency.

**Bass Equalizer Frequency Hz:** parametric equalizer center frequency

**Punch:** punch enhancer (0 off, 2 max). Give some nice "analog-style" bass enhancing.

**Bass Clip Threshold dB:** bass clipper threshold, the threshold beyond which the bass clipper begins to cut.

**Bass Clip Softness:** bass clipper curve selection.

Bass clipper will have a curve progressively softer with increasing value.

A softer curve reduces the distortion introduced by the clipping in contrast, setting to zero (corresponding to the hardest curve), will produce a bass rich in harmonics.

### 3.2.2 Audio input-output

This page allows for selection of on air audio input, changing audio output parameters, setting up the audio fallback and the source dependent presets.

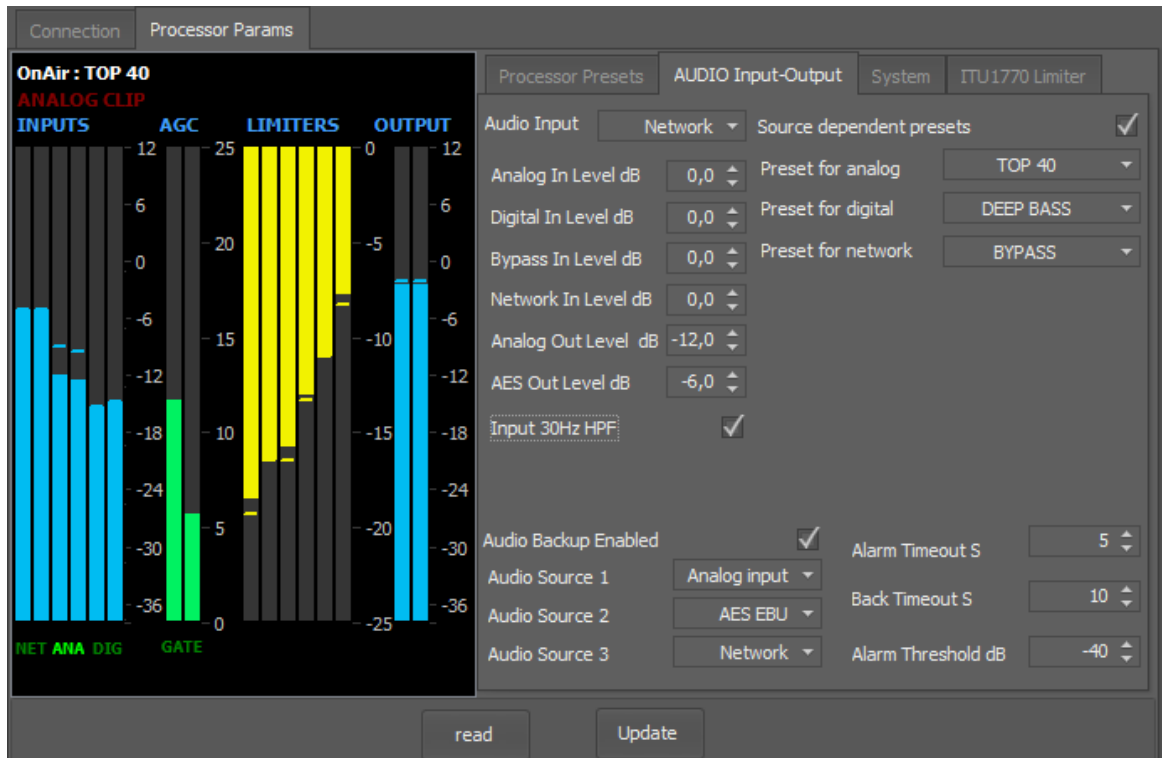

For a detailed description of the following parameters, please refer to [audio input setup](#), [audio output setup](#) and [source dependent presets](#)

[Audio Input, Analog InputLevel, Digital InputLevel, Network InputLevel  
Bypass InputLevel  
Audio OutputLevel  
Audio Backup Enabled  
Source dependents presets](#)

**Input 30Hz HPF:** enables / disables the 30Hz high pass filter for infrasonic component reduction.

**Read:** read parameters from the processor

**Update:** send changes to the processor

### 3.2.3 System setup

In this page it is possible to insert and adjust the network parameters.

The screenshot shows the 'System' configuration page of the DPRO 6 HD Audio Processor. The left panel displays real-time audio processing metrics for the top 40 sources, including input levels, AGC, limiters, and output levels. The right panel contains network configuration fields: NET IP (192.168.1.50), NET MASK (255.255.255.0), NET GATEWAY (empty), and NET PORT (54000). 'read' and 'Update' buttons are located at the bottom of the configuration area.

The network parameters are related to the optional network module only. If the streaming module was installed, network configuration will be done through the web server of the module.

For a detailed description of the following parameters, please refer to [System setup](#)

[NET IP, NET MASK, NET GATEWAY, NET PORT](#)

**Read:** read parameters from the processor

**Update:** send changes to the processor

### 3.2.4 Loudness limiter

In this window is possible to set the loudness limiting reference level, according to the ITU-R BS.1770 standard. The limiting level is shown on the red bar labeled "LIMITER". The "OUT dB LKFS" bar shows the current loudness level with a 400mS integration time.

On the histogram window is shown the loudness level integrated over time. Pressing the "Reset" button will start a new measure and clear all previous values.

For a detailed description of the following parameters, please refer to [Loudness limiter](#) section.

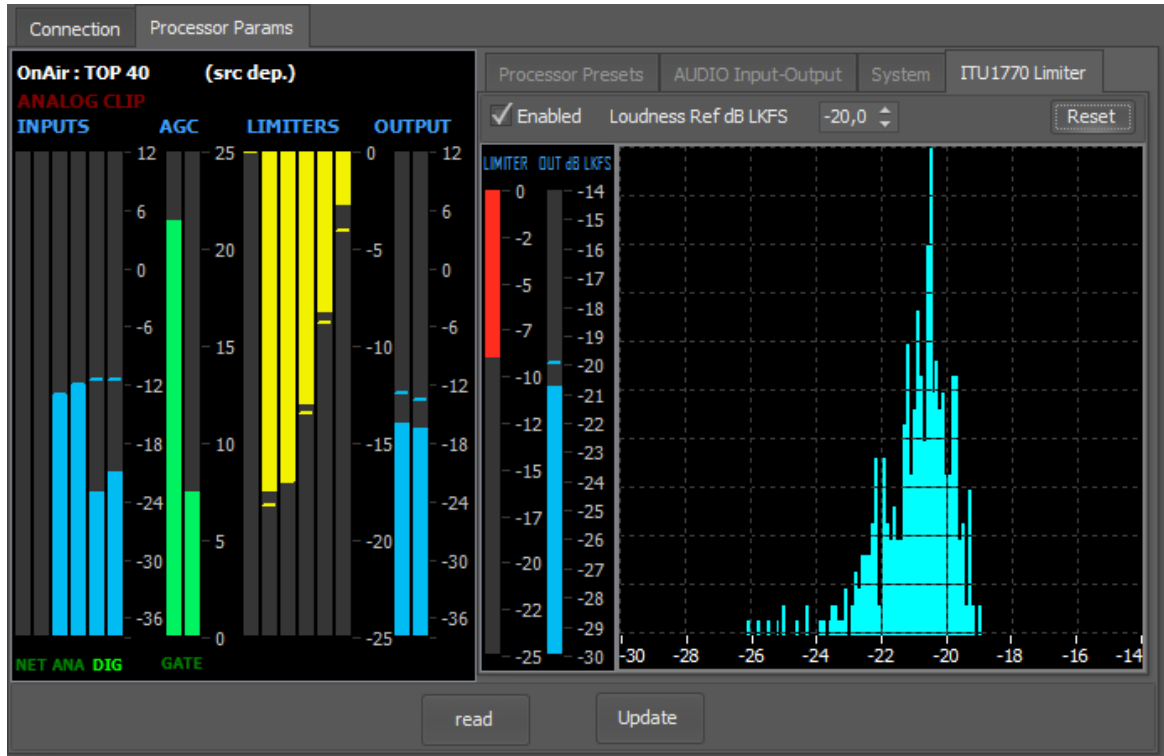

### 3.3 Loading and saving a preset

All the audio presets customized by the user can be saved in files, this preset can be transferred to another DPRO or saved in an external drive.

The remote control software allows to load and save the audio processing presets through the File>Processor menu:

#### Save Usr Presets to Disk

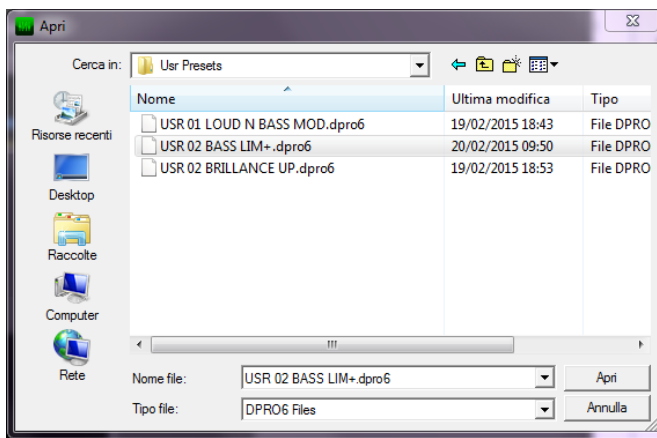
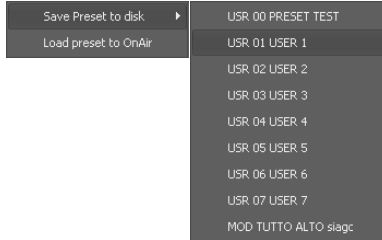

the on air preset will be saved to disk.

#### Load Usr Presets to Onair

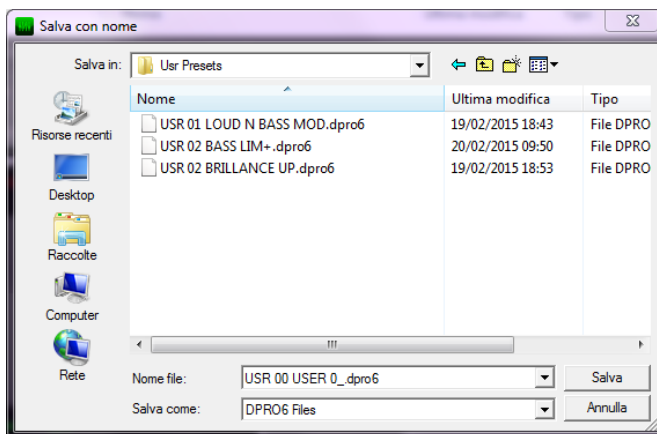
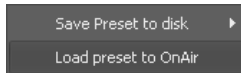

the preset loaded will be put on air.

## 3.4 Loading and saving system

The remote control software allows to load and save the system configuration through the "System" menu, and this includes all parameters listed under "System" and "Audio Input-Output" tabs.

### Save System config to Disk

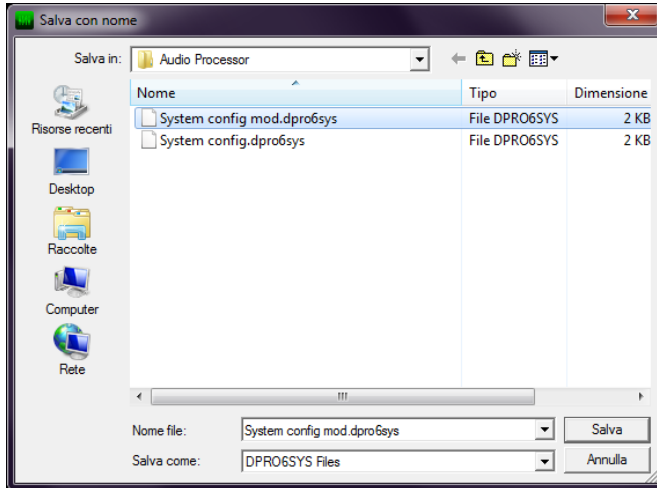
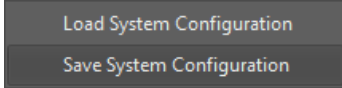

the system configuration will be saved to disk.

### Load System config from Disk

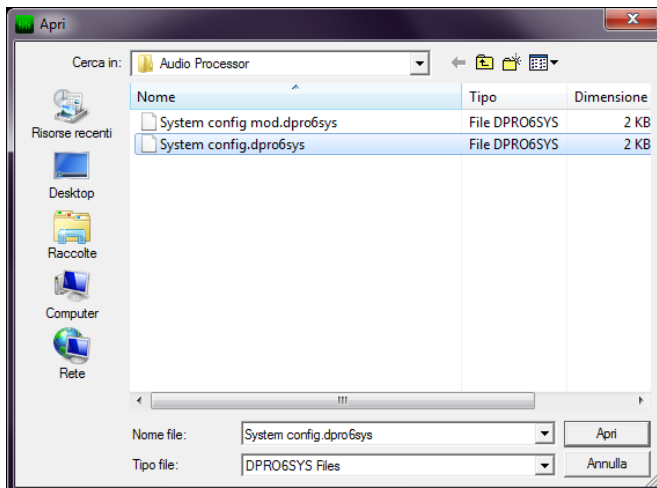
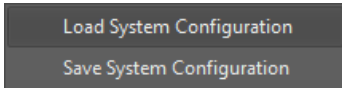

the system config preset loaded in.

### 3.5 Passcode setup

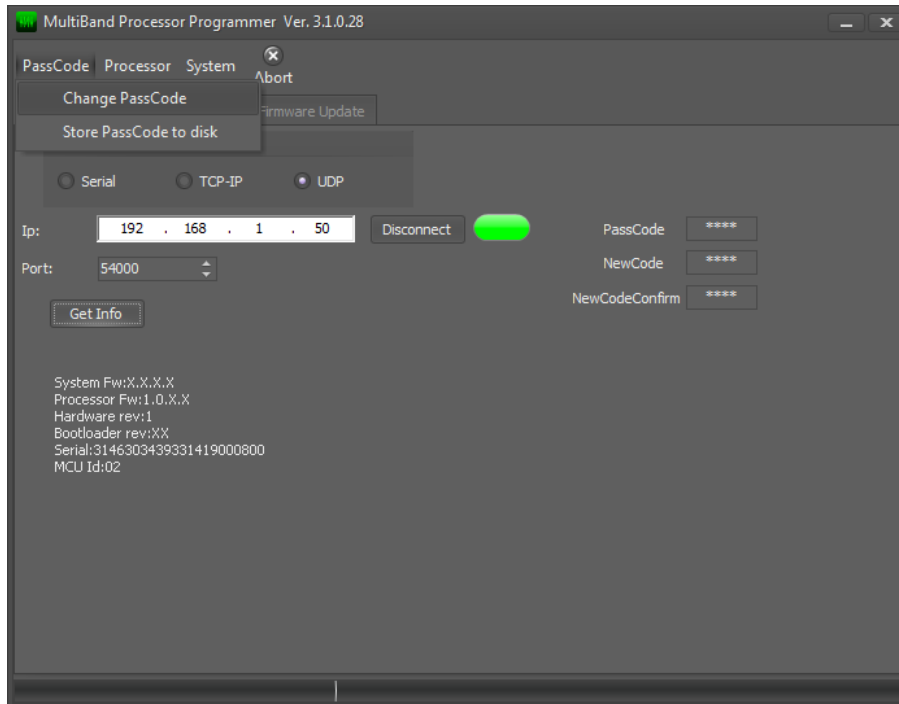

To protect the device from unauthorized operation, a security code can be set. The default code is 0000 (security disabled), but it can be changed through the following procedure:

Put the current Passcode into the PassCode edit box (0000 by default).  
Put a new code into the "New Code" and, the same again, into the "New Code Confirm" editor.  
Go to Menu->PassCode->**Change Passcode**

The user will be prompted for passcode change confirmation, then the passcode will be changed.

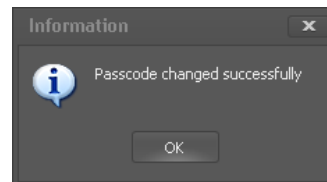
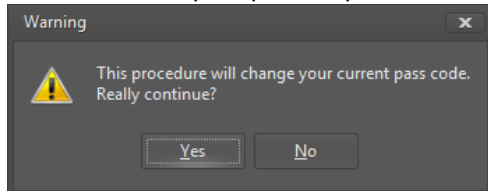

**Store Password to disk:** store the current passcode to not enter it each time the program is used.

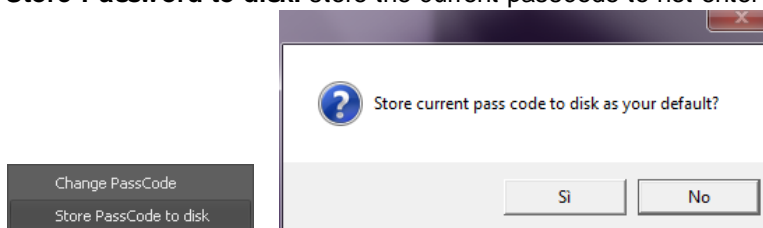

# Section

---

Streaming audio module

# 4

## 4 Streaming audio module

The module adds audio streaming decoding or encoding capabilities for receiving or transmitting streaming HLS / MP3 / AAC + shoutcast servers by HTTP/HTTPS using TCP / IP connectivity. The audio output is transferred in digital format to audio processor / stereo encoder, thus achieving the highest audio quality.

### 4.1 Decoder audio Stream

Connect the apparatus to your LAN and turn it on. Open a web browser on a PC from which the apparatus can be reached and type on the web browser's address bar: <http://192.168.1.100>. The audio module internal webserver should then load the login default page.

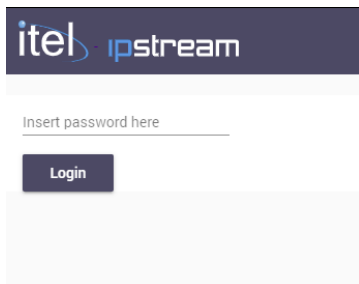

No password set by default, click on the login button and enter the main page.

Go to the "Streaming settings" menu and set one or more URLs from which to receive the audio stream.

Save current configuration by pressing the "Apply settings" button.

**MENU**

- Status
- Streaming settings
- Network Settings
- System Settings
- Open Help
- System Update
- Download finder software
- Logout

**itel ipstream**

**Status**

Streaming Status    Network Status    System Status    System Log

**Main stream: Connected**  
http://192.168.1.222:6001

**Back stream: Connected**  
http://192.168.1.220:6001

**On Air stream:**  
http://192.168.1.222:6001

L Level: -0.0 dB  
-36 -30 -24 -18 -12 -6 -3 0

R Level: -0.0 dB  
-36 -30 -24 -18 -12 -6 -3 0

Buffer Level: 100  
0 50 100

**Metadata**

**Help**

**Status**

**Streaming Status**

This page displays the status of the main and backup streams, the URL of the two streams, the metadata provided by main and backup streams, the status of the pre-buffers expressed as a percentage and audio levels of on-air source. The on-air chain priority is MAIN STREAM->BACKUP STREAM

**Network Status**

This page displays the network configurations for the ethernet interface.

**System Status**

This page shows the status of the system and provide info about firmware version, mac addresses, uptime and global configuration.

**System Log**

Shows the system activity log

The module adds audio streaming decoding capabilities for receiving streaming MP3 / AAC + / HLS shoutcast servers or by using TCP / IP connectivity.

The audio output is transferred in digital format to audio processor / stereo encoder, thus achieving the highest audio quality.

An helpful guide for all settings appears on the side of the configuration page.

On the audio processor, now select the audio input "[NetAudio](#)" and the streaming audio received by the module should be put on-air.

Adjust, if necessary, the input level of audio input "netaudio." If you intend to use any audio processing during streaming audio playback, this setting can also be omitted since the processor will provide for automatic leveling.

The preset for the network input can be chosen into the [next window](#), after "netaudio" input has been selected into the current.

If you want to use more than a single audio source, for using the integrated automatic audio fallback, proceed to its selection and its associated audio processing preset.

Finally, turn the [audio fallback](#) on.

#### 4.1.1 Status



In the Status section you can see the page relating to streaming decoding, network settings, system information and event logs.

Streaming Status

Network Status

System Status

System Log

**Main stream:Connected**

http://ice03.fluidstream.net/onedancech.mp3

**Back stream:Disconnected**

http://none

**On Air stream:**

http://ice03.fluidstream.net/onedancech.mp3

L Level: -0.1 dB

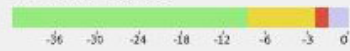

R Level: -0.1 dB

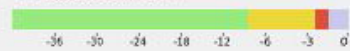

Buffer Level: 74

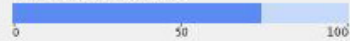
**Metadata**

Feel It - FPI Project

### Streaming Status

This page displays audio decoding information, which URL is currently broadcast, audio levels, buffer status, and decoding metadata (if any).

**On Air Stream:** Describes which URL is currently decoded, if "Playlist" is displayed it means that the player is playing the files present in the memory unit applied to the rear USB DRIVE port.



**Mode:**  
Fixed IP Mode

**Ip Address:**  
192.168.1.100/24

**Gateway:**  
192.168.1.254

**DNS Address:**  
8.8.8.8

### Network Status

The network settings are listed here, the address page can also be viewed from the front display, System menu, Ethernet Settings page.

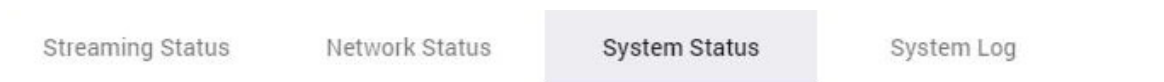

**Firmware:**  
[1.7.0.2]

**Frontend:**  
0.4

**Uptime:**  
up 2 days, 14 hours, 35 minute

**Ethernet Mac Address:**  
00:08:e1:08:33:97

**GMT Offset:**  
1

### System Status

The page contains information relating to the firmware version, Mac address, geographical area and

the uptime counter.

Streaming Status      Network Status      System Status      **System Log**

---

**System Log**

- [23/02/2022 10:52:38 Local] --> System started
- [23/02/2022 10:54:45 Local] --> Logged in from web
- [23/02/2022 10:52:38 Local] --> System started
- [23/02/2022 10:52:38 Local] --> System started
- [23/02/2022 10:52:38 Local] --> System started
- [23/02/2022 10:52:38 Local] --> System started
- [23/02/2022 10:53:59 Local] --> Logged in from web
- [23/02/2022 10:54:12 Local] --> Ethernet settings changed
- [23/02/2022 10:54:18 Local] --> Main stream url changed
- [23/02/2022 10:54:18 Local] --> Backup stream url changed
- [23/02/2022 10:54:20 Local] --> Main stream Disconnected
- [23/02/2022 10:54:20 Local] --> Backup stream Disconnected
- [23/02/2022 10:54:25 Local] --> Main stream Connected
- [23/02/2022 10:54:30 Local] --> Main stream url changed
- [23/02/2022 10:54:30 Local] --> Backup stream url changed
- [23/02/2022 10:55:01 Local] --> Logged in from web

### System Log

System events are stored sequentially in this Log page where they can be consulted for possible verification.

## 4.1.2 Streaming settings

### Streaming settings

The following section allows you to enter the URL addresses to decode, you can enter a main URL and a backup URL in case the first one fails.

### Streaming Settings

Main Stream

Backup Stream

Route Metadata to RadioText

**Main Stream:** Main streaming URL address

**Backup Stream:** Secondary or backup streaming URL address

**Route Metadata to RadioText:** Send the content of the metadata contained in the streaming to the RDS coder in RadioText (if option present and enabled), for management of the RDS coder see the dedicated paragraph.

**Save and apply HTTP Stream Setting:** Save your page changes

**Reboot:** Restarts the stream module.

### 4.1.3 Network settings

#### ↔ Network Settings

On the following page you set the connection mode and network addresses.

Ethernet Settings  Dhcp Mode  
 Fixed IP Mode

Network IP Address  
192.168.1.100/24

Network Gateway Address  
192.168.1.254

Network Dns Address  
8.8.8.8

Save Ethernet Setting

#### Ethernet Settings:

**Dhcp Mode:** IP automatic assignment mode in the presence of Dhcp servers on the network, if DHCP mode is selected, any IP address written in the fields below will be ignored.

**Fixed IP Mode:** How to set a static IP address, the network address must be provided in CIDR notation, i.e. A.A.A.A / XX, where XX is the netmask of the network.

**Network IP Address:** IP address assigned to the stream module.

Below is a netmask conversion table from decimal notation to CIDR.

#### CIDR DECIMAL

/1 128.0.0.0  
/2 192.0.0.0  
/3 224.0.0.0  
/4 240.0.0.0  
/5 248.0.0.0  
/6 252.0.0.0  
/7 254.0.0.0  
/8 255.0.0.0  
/9 255.128.0.0  
/10 255.192.0.0  
/11 255.224.0.0  
/12 255.240.0.0

/13 255.248.0.0  
/14 255.252.0.0  
/15 255.254.0.0  
/16 255.255.0.0  
/17 255.255.128.0  
/18 255.255.192.0  
/19 255.255.224.0  
/20 255.255.240.0  
/21 255.255.248.0  
/22 255.255.252.0  
/23 255.255.254.0  
/24 255.255.255.0  
/25 255.255.255.128  
/26 255.255.255.192  
/27 255.255.255.224  
/28 255.255.255.240  
/29 255.255.255.248  
/30 255.255.255.252  
/31 255.255.255.254  
/32 255.255.255.255

**Network Gateway Address:** Gateway IP address.

**Network DNS Address:** IP address of the domain name server.

#### 4.1.4 System settings

##### System Settings

On the system page we find a string where we can assign a name to the module, password management, audio volume, buffer and communication port.

### System Settings

Device Name  
\_\_\_\_\_

System Password  
\_\_\_\_\_

Retype System Password  
\_\_\_\_\_

Audio Volume (0-31)  
25  
\_\_\_\_\_

Buffer seconds (5-50)  
10  
\_\_\_\_\_

Gmt Offset  
1  
\_\_\_\_\_

Tunnel Port (requires reboot)  
54000  
\_\_\_\_\_

**Save Settings**      **Save Buffer Setting**      **Save System Password**

**Device Name:** device identifier. It is a character label available to the user to identify the device.

**System Password:** To protect access to the streamer's web page, you can enable password security by typing a password in this line.

**Retype System Password:** Repeat the same password to avoid typing errors

**Audio Volume:** Adjustment of the general output level of the stream module towards the audio input.

**Buffer Seconds:** Setting the audio buffer size.

**Gmt Offset:** Selection of the geographical area

**Tunnel Port:** Setting the data communication port for control software Multiband Processor Programmer.

**Save Settings:** Stores audio volume, GMT offset, and tunnel port settings

**Save Buffer Settings:** Save the changes to the Buffer, this operation stops the streaming for a few seconds.

**Save System Password:** Save the changes to the system password, if it is entered it will be asked on the Login page, if the "System password" and "Retype System Password" fields are left empty it will not be asked on the Login page.

#### 4.1.5 System update

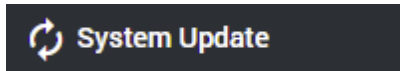

The stream module can be updated via this page.

A light blue form area containing an "Upload file" section with a "Scegli file" button and the text "Nessun file selezionato", and a "Do Update" button below it.

Upload file

Scegli file Nessun file selezionato

Do Update

Once you have obtained the upgrade file from the website [www.itel.it](http://www.itel.it), to start the update procedure press "Choose File" and search your PC for the downloaded file. Once the selected file name is displayed, press "Do Update" to start the update procedure, wait for the module to restart, after about a minute refresh the page.

### 4.1.6 Finder software

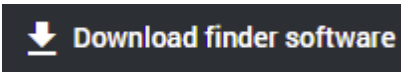

Using the Download Finder Software button you can download the software utility useful for finding the IP address of the stream module. If the module address is unknown, connect the device directly to a PC and use the downloaded utility "IpStream\_Finder.exe" to retrieve the IP address.

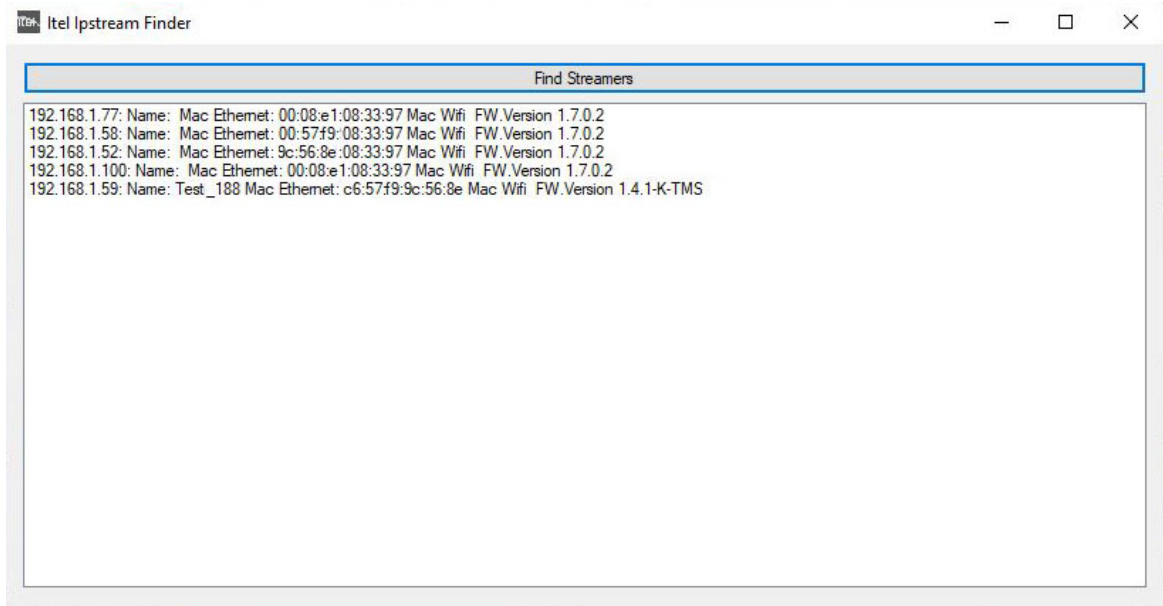

## 4.2 Encoder audio Stream

The audio streaming encoder module has the task of generating a streaming stream in the IP network, various encoding formats allow the transmission of the audio generated by the processor over the network to shoutcast / icecast servers, even in low latency, using RTP, UDP, Multicast or TCP / IP connectivity.

AvailableCodec:

- MP3 fino a 320kbps, (VBR e CBR),
- PCM 16bit @8, 16, 22.05, 24, 32, 44.1, 48 kHz
- G.711, uLaw, aLaw

An helpful guide for all settings appears on the side of the configuration page.

## 4.3 Quick setup

The default IP address is **192.168.1.100**.

*If the IP is unknown, connect the the processor directly to a PC network card, then use the supplied utility "module\_finder.exe" to recover its IP address.*

Connect the apparatus to your LAN and turn it on. Open a web browser on a PC from which the apparatus can be reached and type on the web browser's address bar: `http://192.168.1.100`.

The audio module internal webserver should then load the default page.

Go to the "CONFIG" menu and set one or more URLs from which to receive the audio stream.

Save current configuration by pressing the "SAVE & REBOOT" button, wait for the restart of the module.

Configure the network settings of the module: SETUP -> NETWORK

Save by pressing the "SAVE & REBOOT" button, wait for the restart of the module.