

DPRO3 FM

User's manual



Author	A.Tomassini
Version	3.2.3 - 10/12/2024
Copyright	© 2024 ITEL Elettronica e Telecomunicazioni Snc

Table of contents

Section 1 Description	6
1 List of changes	6
2 Warnings	6
3 Front panel	7
4 Rear panel	7
5 Editing and navigation	8
Section 2 Front panel display	11
1 Audio processor	11
Compression levels	11
AGC	11
Loading a preset	12
Saving a preset	12
Gate level and compressor drive	13
Bypass	13
Compression level and master release time	14
Band link and equalization	14
Bass parametric eq	14
Bass clipper/limiter	15
Stereo expander	15
2 RDS Coder	16
RDS level and flags	16
PI,PTY	16
PS and Radiotext monitor	17
PS Editor	17
RT Editor	17
AF list Editor	18
3 Audio input setup	19
Audio levels monitor and input level setting	19
Audio source setup	19
Audio processor preset selection	20
Audio fallback setup (audio backup)	20
4 Audio output setup	21
Audio output regulation	21
5 MPX output setup	21
MPX modulation and pilot subcarrier setup	21
Output level setup	22
6 System setup	23
Display, Source Dependent Presets, Device ID	23
GPI and MPX changeover option (Split)	23
PassCode Setup	25
Ethernet setup	25
System info	26

Options	26
Login window	26
7 Headphones Level	28
Section 3 Programmng software	30
1 Main window	30
2 Processor Params	31
Processor Presets	31
Audio input-output	33
System setup	34
3 Loading and saving a preset	35
4 Loading and saving system	36
5 RDS	37
RDS Flags window	37
PS window	39
Radiotext window	40
AF Lists window	41
Editing	42
A Method	43
B Method	43
Loading and saving RDS coder configuration	45
6 Passcode setup	46
Section 4 RD Link	48
1 Radiotext Plus	48
2 Monitor	50
3 Configuration	52
Setup	52
Program ID.....	52
Radiotext Plus and dynamic PSN.....	52
TA - Clock time.....	53
Communication interface and additional settings	54
Raw Text Importer	55
Word filter	56
4 Scheduler	57
Section 5 Streaming audio module	62
1 Decoder audio Stream	62
Status	63
Streaming settings	67
Network settings	68
System settings	70
System update	71
Finder software	72
2 Encoder audio Sream	73
3 Quick setup	73

Section

Description

1

1 Description

This product is a fully digital audio processor with integrated MPX stereo encoder and RDS (option). The audio processor is implemented through a traditional three band limiter.

This configuration, although simple, allows for a natural, well balanced sound, yet having a good onair presence.

Audio processing, MPX coding and RDS signal are all realized using DSPs, allowing for stable performance over time and extending functionality with firmware upgrades.

1.1 List of changes

1.1.0 17/06/2014	first release
2.0.0 23/09/2014	updated to new firmware 2.0 features
2.0.1 20/11/2014	updated to new firmware 2.1 features
3.0.0 10/03/2015	updated to new firmware 3.0 features
3.1.0 25/01/2016	updated to new firmware 3.1 features
3.2.0 14/09/2016	updated to new firmware 3.2 features

1.2 Warnings



Before attempting any operation, please follow the safety instructions contained in the following paragraph.

The producer declines any liability for damage to people or things due to non-compliance, even if partial, of the following indications

- Ensure that the supply voltage corresponds to what is indicated on the apparatus.
- Ensure that the electrical system is equipped with a ground connection.
- Use only power sockets and cables with ground connection
- Disconnect power before attempting any operation inside the device.
- The power cutting device is the power cord, so this should be easily accessible and the socket must be positioned close to the apparatus.
- Any operation involving the access to internal parts must be performed only by trained service personnel.

1.3 Front panel



Front panel indicators and rotary knob

Headphone stereo jack 6,3mm (1/4")

- GATE: Led is on when level is below gate threshold
- CLIP: The analog input level is too high.
- DIG IN: AES/EBU digital input is selected as audio source
- NET: Network audio is selected as audio source(option).

- AGC: Input AGC gain level
- MULTIBAND LIMITER: Multiband limiter compression level

Menus navigation and parameter editing is done through the rotary knob.

1.4 Rear panel

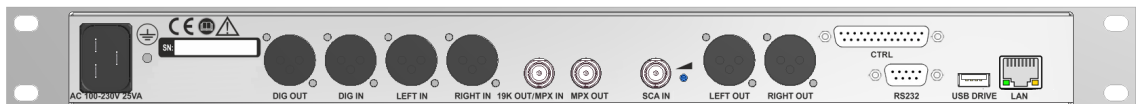

Connectors on rear panel

- DIG OUT (XLR M) AES/EBU output
- DIG IN (XLR F) AES/EBU input
- LEFT IN (XLR F) Left analog input
- RIGHT IN (XLR F) Right analog input
- 19K OUT (BNC F) 19KHz output for external RDS encoder synchronization. (1Vpp trapezoidal wave)
- MPX OUT (BNC F) Composite MPX output (+6/-6dBm)
- SCA IN (BNC F) External SCA / RDS input (will be mixed to MPX output with a gain of -20dB)
- LEFT OUT (XLR M) Left channel analog output
- RIGHT OUT (XLR M) Right channel analog output
- RS232 (DSUB 9F) RS232 connector
- USB DRIVE (USB-A) USB connector for fallback audio on external drive (option)
- LAN (RJ45) LAN connector for remote control or streaming audio module (option)

1.5 Editing and navigation

Menu navigation and parameters editing is done by the front panel knob.

On the main menu which appears after firmware boot, is possible to select the submenu for the various settings.

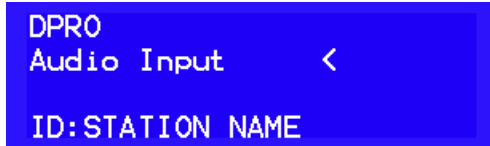

Pressing the knob, will enter the selected submenu.



Once entered in the desired sub-menu, if there are adjustable parameters, you can proceed to editing

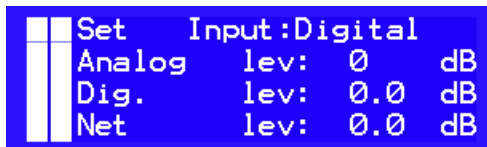

Pressing the knob, an asterisk "*" will appear next to the first editable element. This will not happen if, on the current window, there are no editable parameters.

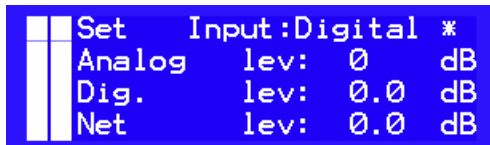

Turn the knob to position the "*" cursor on the other editable elements of the current window.

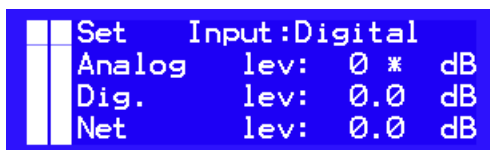

If you want now to change the analog input sensitivity, press the knob again. A "<" symbol will appear next to the parameter to indicate that this is being edited.

```

Set      Input:Digital
Analog  lev:  0 < dB
Dig.    lev:  0.0 dB
Net     lev:  0.0 dB

```

Turning the knob, you now will modify the selected parameter's value.

```

Set      Input:Digital
Analog  lev: -6 < dB
Dig.    lev:  0.0 dB
Net     lev:  0.0 dB

```

Once set the desired value, press the knob again. The cursor will switch to "*" again, indicating that items navigation mode is now active and other items can be selected and edited as described before.

```

Set      Input:Digital
Analog  lev: -6 * dB
Dig.    lev:  0.0 dB
Net     lev:  0.0 dB

```

If editing is however terminated, press the knob again and the "*" cursor will disappear and you can rotate the knob to navigate to other windows.

```

Set      Input:Digital
Analog  lev: -6  dB
Dig.    lev:  0.0 dB
Net     lev:  0.0 dB

```

Inside any submenu, pressing the knob for more than 3 seconds, will cause a jump to the main menu.

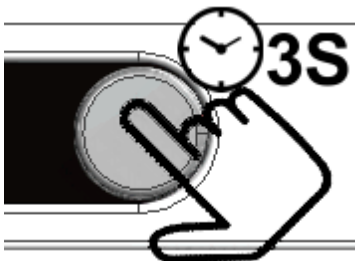

```

DPRO
Audio Input  <
ID:STATION NAME

```

When pressing the knob for 1 seconds, will appear the [Headphone Level](#) regulation.

Section

Front panel display

2

2 Front panel display

Following are listed all menus and functionalities available on the current firmware release.

2.1 Audio processor



Into this section are comprised all functions and menus related to the audio processor.

2.1.1 Compression levels

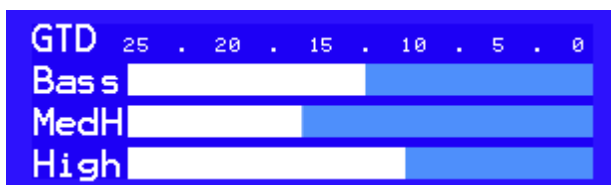

In the window, the compression-limiting levels of the three bands are shown. The "GTD" label, if visible, indicates that the audio level is below the gate threshold.

2.1.2 AGC

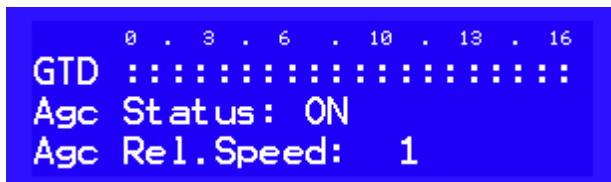

This window contains the settings for automatic gain control (AGC) block, placed at the head of audio processing chain.

The automatic gain control performs a pre-leveling of the signal applied to the following compressors/limiters, keeping their working point almost constant.

At the right side of the bar which indicates the level of pre-amplification applied to the input signal, is placed the AGC status indicator: if "AGC" is displayed, the input level is above the gate threshold and the AGC and compressors/limiters are operating correctly, if "GTD" is displayed it means that the input signal is below the minimum level so the compressors release is slowed down and the AGC slowly decrease its gain down to 0dB.

AGC Status (On / Off): Enables / disables the AGC operation.

Agc Rel.Speed (0..10): AGC release speed. By increasing this value, you will get a faster recover when audio input gets quieter.

2.1.3 Loading a preset

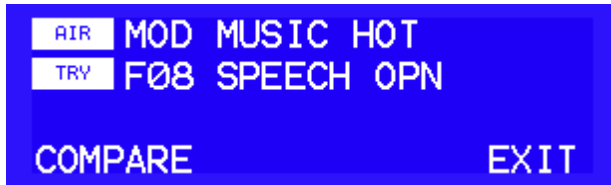

The "AIR" field shows the on-air preset name, while, in the "TRY" field, can be specified the name of a new preset to load. Once selected the desired preset, go on the "COMPARE" label which will start to flash.

When "COMPARE" is flashing, pressing the front panel knob will cause the "TRY" preset to go on-air while the previously on-air preset will go to "TRY", allowing for comparison.

If [Source Dep.Presets](#) function was enabled, it will be possible to specify a different preset for each [audio source](#) selected so, in this case, the source for which the current preset is used will be displayed.

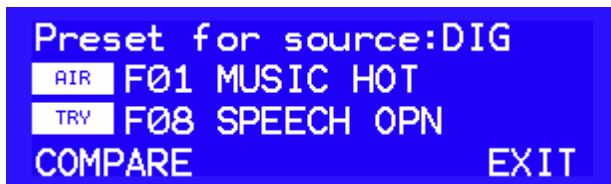

It is possible to change the audio source from [Audio Input](#) menu.

If necessary, make any editing you want to the factory preset (any preset starting with Fxx) selected, then save the preset to a user memory (Uxx).

Once saved, the preset will become the audio processing preset for the selected audio source, or the general preset used for all sources, depending on whether or not the function "Source Dep.Presets" was enabled.

A modified, but not saved, preset will be marked by the "MOD" prefix. This preset will be overwritten if a new preset is loaded and then edited.

Mode F00: BYPASS, has the input level as the only editable parameter and this is the same both for the Analog / AES EBU source and NetAudio.

In the case where it is necessary to put have the processor in bypass mode when any of the two sources are selected, it will be possible to compensate the differences in audio levels, if any, adjusting their input levels from the audio input menu.

If one of the sources is the Analog channel, we recommend to set the input level of the AD converter in coarse 6dB steps, then use the bypass input level for fine tuning of Analog source, then adjusting the level of the other channel, netaudio or AES EBU, from the audio input menu

2.1.4 Saving a preset

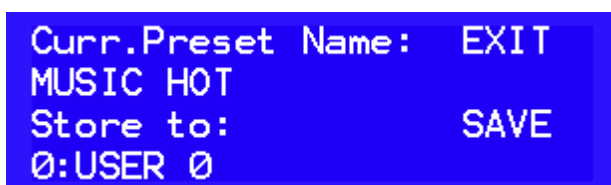

Curr Preset name shows the name of the preset which is actually on air The name can be changed

following the editing rules described before. When name editing is finished, the "*" cursor will be positioned to the right side of the name string and will allow to move on the other editable elements on the window.

Once the preset name has been edited, you can choose an user file to store it, then go to "SAVE" button which will start to flash. Pressing now the knob will result in saving the preset to the specified user file.

2.1.5 Gate level and compressor drive

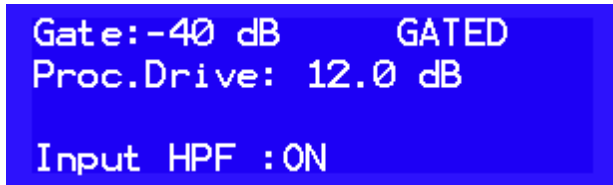

Gate: the gate threshold is the level below which the release time is greatly increased, still allowing for a slow recovery of the volume but avoiding to amplify any background noise during short breaks. The indication "GATED" is visible if the input level is below the threshold.

Drive: indicates the compressor/limiter driving level, thus determining the compression level.

A high level of compression will produce a steady and dense sound, while a lower level will result in a more natural and dynamic sound.

Adjust the drive control to have a compression of approximately 15 dB (which is not critical) as it will accomodate for most musical genres.

Input HPF (ON/OFF): enables / disables the 30Hz high pass filter for infrasonic component reduction.

2.1.5.1 Bypass



If the selected process is "F00: BYPASS", the only editable parameter will be the input level and the bar will indicate the clipping level.

No other parameter is used, so the other editing windows will be hidden.

2.1.6 Compression level and master release time

```
Compression: 80 %  
Release      : 40 %
```

Compression: sets the tradeoff between clipping and compression limiting. Reducing this value, you will get a louder sound at the expense of more distortion, on the contrary, raising the compression level will result in a quieter but cleaner sound.

Release: sets the compressor release time. Shorter times will raise the perceived loudness but compression artifacts might become evident.

2.1.7 Band link and equalization

```
BandLink    : 80 %  
Brilliance  : 40 %  
Presence    : 2.0 dB
```

BandLink: set the maximum compression difference between bass and middle/highs band. Setting this value to zero, the bass compression level will be totally independent and this will cause also a mild auto-equalization.

Setting this value to 100%, it will force the bass compressor to have a gain never greater than the middle/highs band giving a sound very close to the original.

Brilliance: high band (>6KHz) shelf equalizer.

Presence: 2KHz boost/cut filter.

2.1.8 Bass parametric eq

```
BassEqFreq: 65 Hz  
BassEqGain: 0.0 dB  
BassEq Q: 1.40
```

BassEqFreq: parametric equalizer center frequency

BassEqGain: gain (boost) of parametric equalizer.

BassEq Q: Q-factor (bandwidth) of parametric equalizer.

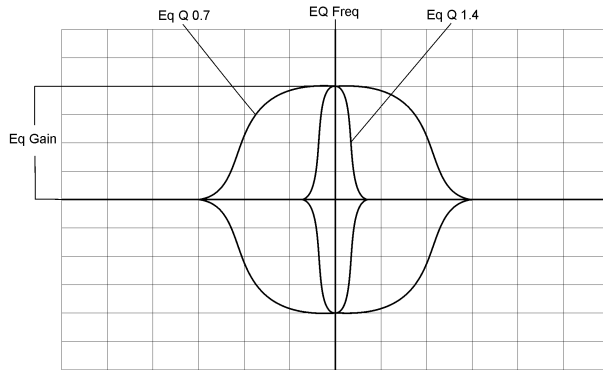

2.1.9 Bass clipper/limiter

```
Bass Lim Thr: -1.6 dB
Bass Lim Release: 60 %
Bass Clip Thr: -5.0 dB
Bass Clip Softness: 3
```

Bass lim thr: bass limiter threshold. Increasing this value will result in a bass band control mainly done by the clipper. Reducing it, the control will be mainly done by compressor.

Bass lim release: compressor release time.

The low band release time is adjusted in percentage respect to the master band release time.

A setting of 50%, for example, indicates that the bass band will have a release time equal to half the time of the medium-highs band.

Shorter release times will increase the presence of low frequencies.

Bass clip Thr: bass clipper threshold.

Bass clip softness: bass clipper curve selection.

Bass clipper will have a curve progressively softer with increasing value.

A softer curve reduces the distortion introduced by the clipping in contrast, setting to zero (corresponding to the hardest curve), will produce a bass rich in harmonics.

2.1.10 Stereo expander

```
Stereo Expander: OFF
Level : 0 %
```

In this window is possible to set the stereo expander.

Stereo EXPANDER ON/OFF: the stereo expander is activated (ON) or excluded (OFF)

Level: expansion level.

Though the stereo expander level is self-limited, we recommend listening to more songs in order to choose the most appropriate level of expansion.

Exaggerated stereophonic expansion might increase the multipath induced interference.

2.2 RDS Coder

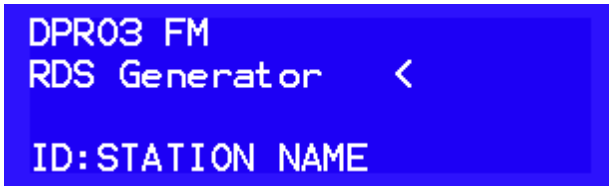

```
DPRO3 FM
RDS Generator <
ID:STATION NAME
```

Into this section are comprised all functions and menus related to the optional RDS encoder.

2.2.1 RDS level and flags



```
RDS: ON  LEV:3.0 KHz
TP:OFF TA:OFF RT:OFF
MS:MUS  COMPR: ON  AH:OFF
```

RDS(ON/OFF): sets the coder on and off.

LEV: RDS subcarrier level

TP (ON/OFF): sets the TP flag status

TA (ON/OFF): sets the TA flag status

RT (ON/OFF): radiotext enable

MS (MUS/SPC): sets the MUSIC/SPEECH flag status

COMPR (ON/OFF): sets "COMPRESSED" flag status

ARTIFICIAL HEAD (ON/OFF): sets "ARTIFICIAL HEAD" flag status

The "mono/stereo" flag is switched automatically, depending on the [MPX modulation](#) type selected.

2.2.2 PI,PTY



```
PI:5330
PTY:09 Varied
SAVE
```

PI: PI code setting

PTY: Program Type, settings

Changes will take effect once saved.

2.2.3 PS and Radiotext monitor

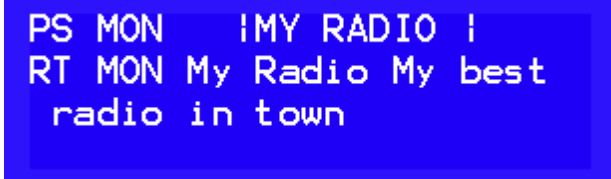

```
PS MON   MY RADIO I
RT MON My Radio My best
radio in town
```

PS MON: Program Station Name actually on air.

RT MON: Radiotext actually on air.

If the Radiotext Plus is active for the currently aired Radiotext string, a "+" symbol will be appended to the "RT" label.

Radiotext Plus, Dynamic PSN and CT (clock time) functions are available using the supplied software RD-Link

2.2.4 PS Editor

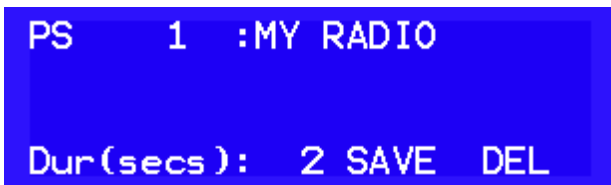

```
PS      1  :MY RADIO
Dur(secs): 2 SAVE DEL
```

In this window you can enter and edit PS strings that will be displayed by the receiver, each of which can be up to 8 characters long.

PS 1..24: selection of the item to edit.

Dur (secs): display time, in seconds, of the currently selected string . A duration of zero, will disable the display of the string.

SAVE: Save the modified item

DEL: delete the selected item

User must save changes before selecting a new string or before exiting the window, otherwise they will be lost

2.2.5 RT Editor

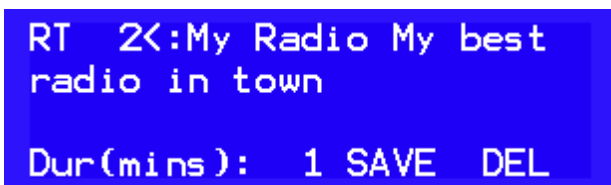

```
RT 2<:My Radio My best
radio in town
Dur(mins): 1 SAVE DEL
```

In this window you can enter and edit RT strings that will be displayed by the receiver, each of which can be up to 8 characters long.

RT 1..24: selection of the item to edit.

Dur (mins): display time, in minutes, of the currently selected string . A duration of zero, will disable the display of the string.

SAVE: Save the modified item

DEL: delete the selected item

User must save changes before selecting a new string or before exiting the window, otherwise they will be lost

2.2.6 AF list Editor



```
AfList: 1 Freqs:14
Freq #: 1 101.0
Freq INSERT DELETE
List SAVE CLEAR
```

Alternative frequencies editing window .It is possible to insert up to 25 frequencies on the first list for the method "A", or 24 lists for method "B". For more details on the differences between the A and B modes, please refer to the [AF List window](#) of programming software.

AfList 1 ... 24: selection of the AF list to be edited.

Freqs: indication of the number of frequencies into the selected list.

Freq #: selection of the frequency number in the list, from 1 to 25, to be edited.

Freq INSERT: Insert a new frequency in the "Freq #" position. The other frequencies in the list will be shifted accordingly.

Freq DELETE: the current frequency will be deleted.

List SAVE: saves the changes

List CLEAR: deletes all frequencies in the current list

Notes:

The list, once modified, will be used only after it has been saved using the SAVE button. Selecting a different list (AfList) or exiting the editing window before saving the list, will result in losing all changes.

Any empty frequencies (--) eventually contained into the list, will be deleted automatically upon saving.

2.3 Audio input setup

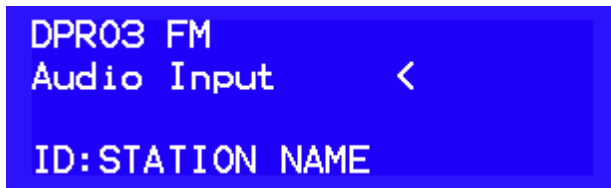

In this section are present all controls related to audio sources and [automatic audio fallback](#)

2.3.1 Audio levels monitor and input level setting



In the current window is displayed, with greater accuracy, the input level of the selected channel.

The input level of the selected channel can be adjusted, but the channel will not be put on air. To change the on air input channel, the following window must be used.

2.3.2 Audio source setup

Audio input: Analog, analog input
Digital, AES/EBU input
NetAudio, streaming audio input.

Analog lev: audio input attenuator level. This adjustment sets the input level to the A / D converter. The nominal level is indicated in the bars:

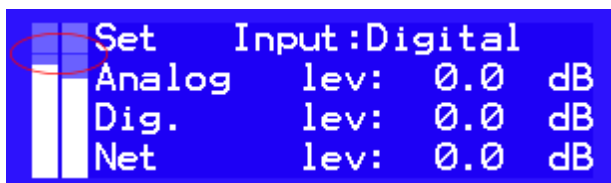

The initial adjustment of the input level should be made so that the maximum analog input level is equal to or only slightly above that limit.

In no case the front panel "CLIP" led should light.

Dig. lev: AES/EBU level adjustment

Net lev: streaming module level adjustment.

The adjustment of the individual channels is in 0.1dB steps.

2.3.3 Audio processor preset selection

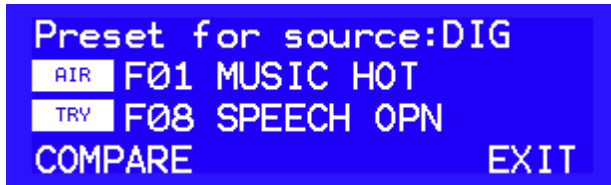

If [Source Dep.Presets](#) function was enabled, it will be possible to choose a different preset for each audio source, which can be selected in the previous menu, otherwise this window will not be visible. Once selected a preset, it can then be edit into the Audio Processor section.

The loaded preset will be assigned to the audio source currently on air.

2.3.4 Audio fallback setup (audio backup)

The processor can be set to automatically switch to an auxiliary input source if the main input audio level is below a minimum threshold.

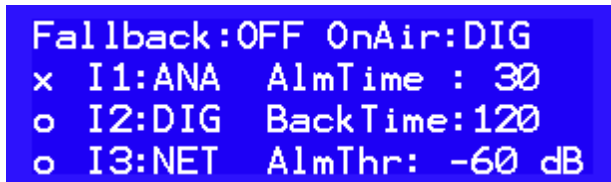

Fallback (ON/OFF): Enable / Disable automatic audio fallback on backup source.

OnAir: audio source actually on air

I1 - I2 - I3: Channel list. The channel are listed by order of priority, with maximum priority assigned to channel 1.

When an high priority channel will become unavailable, it will be replaced by a lower priority one until its recovery.

AlmTime: Alarm timeout

Back Time: Back timeout. It is the time for which the main audio source must be above the minimum threshold before it can be set back on air.

AlmThr: minimum audio level threshold

The main audio source is considered valid If the level of both channels L / R are above the alarm threshold. If a single channel is less than the alarm threshold for a period longer than the alarm timeout, the backup source will be put on air.

When the main audio source will recover, once elapsed the "Back Timeout", it will be put back on air.

Changes will be applied upon exiting the menu.

2.4 Audio output setup

```
DPR03 FM
Audio Output <
ID:STATION NAME
```

This section contains the settings relating to the DIG OUT - L R OUT audio outputs.

2.4.1 Audio output regulation

```
ANA Out lev : 0.0 dBu
DIG Out lev : -6.0 dBFS
OUT deemph : 50uS
Out pos: Post clip&filt
```

ANA LR Out : audio output level on rear XLR Left-Right OUT connector.

DIG LR Out : output audio level on rear XLR DIG OUT connector

Out deemph: output audio deemphasis. This is related only to the audio output, not to MPX output.

Out pos: point of acquisition of the output signal, it can be selected form:

Post clip&filt: output signal is taken after clipper and lowpass filter.

Pre filter: output signal is taken prior the lowpass filter, but after the clipper.

Pre clipper: output signal is taken before the clipper.

2.5 MPX output setup

```
DPR03 FM
MPX Output <
ID:STATION NAME
```

2.5.1 MPX modulation and pilot subcarrier setup

```
Modulation : Stereo
Preemphasis : 50us
Pilot Level : 5.0 KHz
Pilot Phase : 0.00 Deg
```

Modulation (stereo, mono l+r, mono L, mono R):

Stereo: stereo modulation

Mono L+R: monoaural modulation from L+R channels sum.

Mono L, Mono R: monoaural modulation from a single channel.

Preemphasis: 50/75uS preemphasis, it should be set according to local FM broadcasting standards.

Pilot level: 19KHz pilot tone injection level.

Pilot Phase: pilot tone phase adjustment.

2.5.2 Output level setup

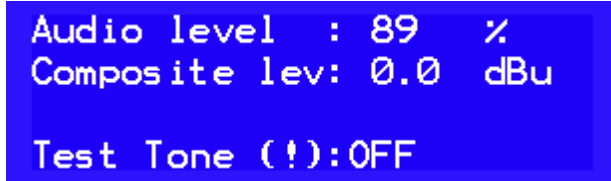

```
Audio level : 89 %
Composite lev: 0.0 dBu
Test Tone (!): OFF
```

Audio level: percentage of audio signal (L+R, L-R) into the composite MPX signal.

In case of monoaural broadcasting, without RDS and pilot subcarrier, this level can be left at 100%, and this will produce a deviation of 75KHz.

In all other cases it should be reduced according to the level of injection of the two subcarriers, otherwise overmodulation will occur.

For example, if a RDS subcarrier of 2KHz and a pilot tone of 6KHz are desired, the audio signal level can not be greater than

$$100 * (1 - ((\text{PilotCarrierDeviation} + \text{RDSCarrierDeviation}) / 75))$$

which, for the example described above, will correspond to:

$$100 * (1 - ((6 + 2) / 75)) = 89.3\%$$

Composite level: MPX output level.

Test tone (!): when activated, will put on air a 400Hz tone, having an amplitude equal to 100% modulation.

If RDS and pilot subcarriers were correctly set, the final modulation will not go above this limit.

2.6 System setup

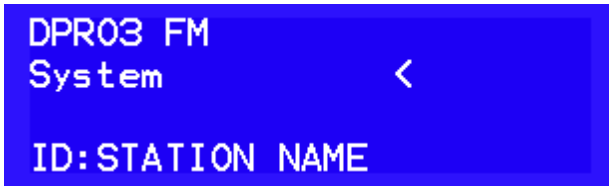

```
DPR03 FM
System <
ID:STATION NAME
```

2.6.1 Display, Source Dependent Presets, Device ID

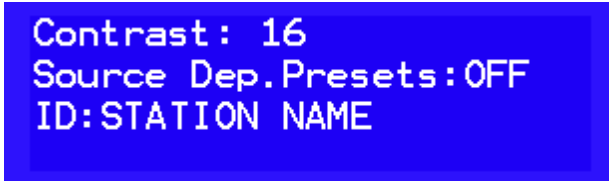

```
Contrast: 16
Source Dep.Presets:OFF
ID:STATION NAME
```

Contrast: display contrast adjustment.

Source Dep.Presets: enable/disable audio preset selection depending on audio source.

ON: if the function is enabled, a different audio processing preset can be specified for each audio source.

OFF:if the function is disabled, the same preset will be used for all audio sources.

ID: device identifier. It is a 16 characters long label which will be shown in the main menu screen, useful for identification when multiple devices are installed.

2.6.2 GPI and MPX changeover option (Split)

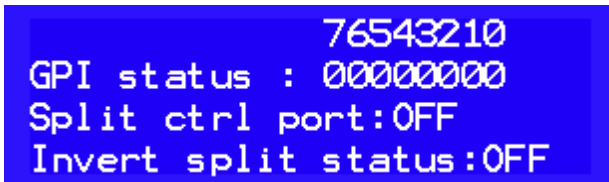

```
76543210
GPI status : 00000000
Split ctrl port:OFF
Invert split status:OFF
```

In this menu it is possible to remotely select the channel to be broadcast or manage an MPX advertising split in output (option). The election is possible via GPI, serial and Network card.

GPI status: status of the 8 available ports, from 7 to 0.

Split ctrl port: enable the function and select the communication mode.

OFF: disabled function.

GPI: active function on CTRL port.

Serial: active function on RS-232 port.

Network: active function on Ethernet port.

Invert split status: invert commutation MPX Input set on GPI mode

OFF: without command it is set in [NETWORK] mode.

ON: without command it is set in [SPLITTING] mode.

The split status is shown at the top of the display.

In [SPLITTING] mode, in MPX output there is the processed signal coming from Analog or Digital Inputs or Net Ip stream (if present).

In [NETWORK] mode, in MPX output, the signal applied to MPX IN is present.

Rear Connectro GPI (CTRL)

GPI port status:

0: Pin 6 - Set ANALOG Input

1: Pin 2 - Set DIGITAL Input

2: Pin 7 - Set NET/IP Input

3: Pin 3 - Set MPX Input (SPLIT)

4: Pin 8 - Not used

5: Pin 4 - Not used

6: Pin 9 - Not used

7: Pin 5 - Not used

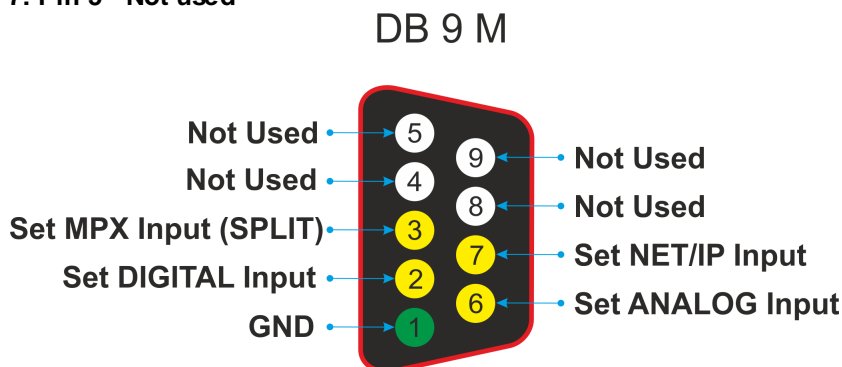

The inputs are activated by grounding the relative pin or by providing a voltage from 5 to 12VDC, in this case the jumpers placed on the board inside the device will have to be moved from the "CLOSE" to "VIN" position.

The selection of the channels through the GPI port takes place with exclusive priority on a single channel, if more inputs are activated at the same time the channel is restored before the selection, only the MPX channel has absolute priority and at each activation it does not take into account the status of the other 3 inputs by bringing the MPX IN signal to MPX OUT.

Example 1: the Analog channel is on the air, pin 2 is activated by broadcasting the Digital channel, at the same time pin 7 NET / IP is also activated, since the selection of two channels is not valid at the same time, the channel returns to air Analog.

Example 2: the Digital channel is on the air, pin 6 is activated by broadcasting the Analog channel, at the same time the MPX pin 3 is activated, the analog channel remains active but the MPX output is switched to MPX IN.

Network command by lan:

By selecting Network on "Split ctrl port" commands can be sent via LAN using the UDP protocol with standard ethernet card, the TCP protocol with IP Streaming option card.

```
[AB010103] select analog input
[AB010200] select digital input
[AB010301] select NET/IP input
[AB010406] / [AA010001] select MPX input
[AB010002] o [AA010100] return on main channel
```

The selection command must be repeated continuously otherwise the device re-enters the main channel.

2.6.3 PassCode Setup

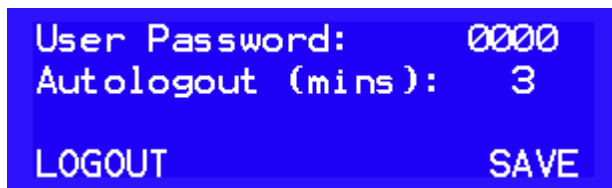

```
User Password: 0000
Autologout (mins): 3
LOGOUT SAVE
```

User Password: in this section the user can enter a numeric password that will be required for accessing the device. Setting "0000" (default value) will disable the password prompt.

Autologout (mins): Automatic lock timeout. If no action is done on the front panel knob within the specified time interval, the device will enter into lock state and the user will need to re-enter the password to log in again.

LOGOUT: immediate logout and lock.

SAVE: Saves any changes made to the numeric password or the duration of the automatic logout timing.

2.6.4 Ethernet setup

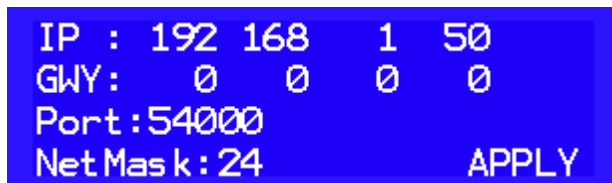

```
IP : 192 168 1 50
GWY: 0 0 0 0
Port: 54000
Net Mask: 24 APPLY
```

IP: current ip address

GWY: gateway address

Port: UDP port number

NetMask: netmask in CIDR notation.

APPLY: apply and save changes.

This page is visible only if the network module is installed.

2.6.5 System info

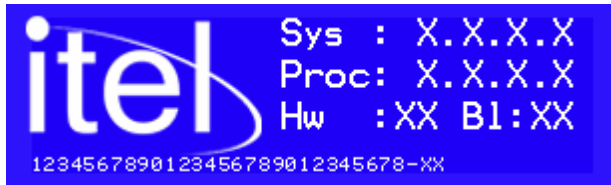

Sys: operating firmware release

Proc: audio processor and MPX coder firmware release

Hw: hardware release

BL: MCU bootloader release

SN: serial number

2.6.6 Options

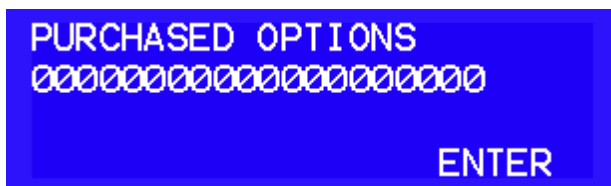

In this window the user must enter the code to enable the optional features.

Once entered the code for the desired option, go to the "ENTER" button and, when it will flash, push the front panel encoder.

The device will verify the code and, if found correct, will activate the requested option.

Example for RDS coder:



2.6.7 Login window

To protect the device from unauthorized operation, a security code can be enabled by accessing the System menu, [Set password](#).

When the device is turned on (or the auto logout time is elapsed), the login page will be shown where the pass code is to be entered.



LOGIN: when the correct pass code is entered, will log in user.

Pass code lost or forgotten: after the 20th unsuccessful login attempt, an unlock code will be displayed. Call customer service and tell this code in order to get back your pass code.



2.7 Headphones Level

The headphone level can be adjusted using the front panel knob. Pressing the knob for more than 1 second, will show the adjustment level menù.

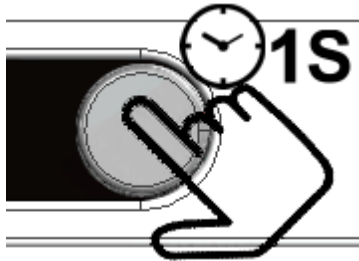

After 3 seconds the level menù will close automatically.

Section

Programming software

3

3 Programming software

A PC based software Processor Programmer, compatible with 32 and 64 bits Windows Xp, Windows 7, Windows 8.X, Windows 10, is provided for processor remote control and setup.

Connection is done through:

- serial port 9600 baud 8N1
- ethernet port TCP-IP (if optional streaming module is installed)
- ethernet port UDP

3.1 Main window

In the main window the type of connection can be selected, via COM port or through Ethernet port using TCP-IP (needs streaming module) or UDP (needs ethernet module). Once the communication mode is set up and the processor connected, press "Connect". If communication is correct, the program will read all internal settings and device information.

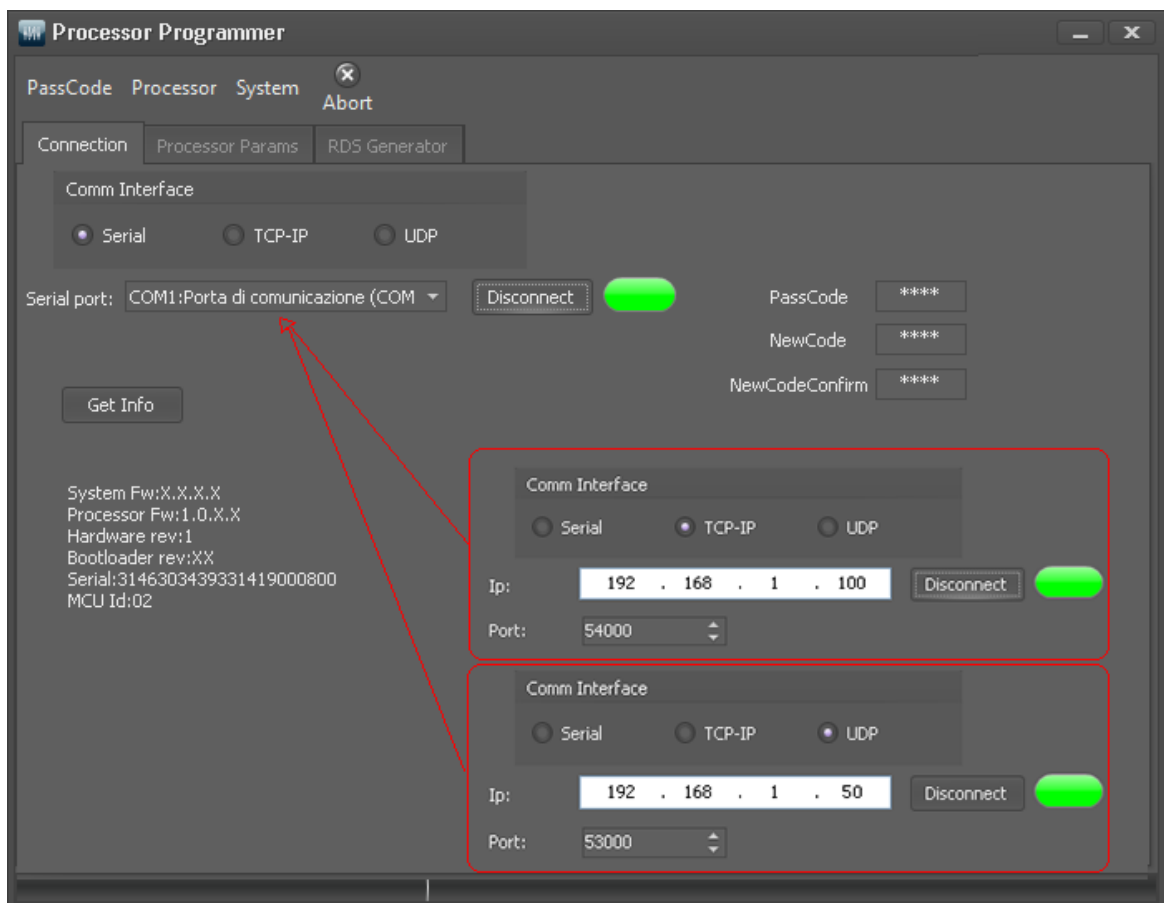

3.2 Processor Params

This section contains the audio process controls and presets, setting of the audio input and output sources and system parameters.

3.2.1 Processor Presets

On this page are shown the input levels, the audio input currently on air, the presets list and the audio processing parameters.

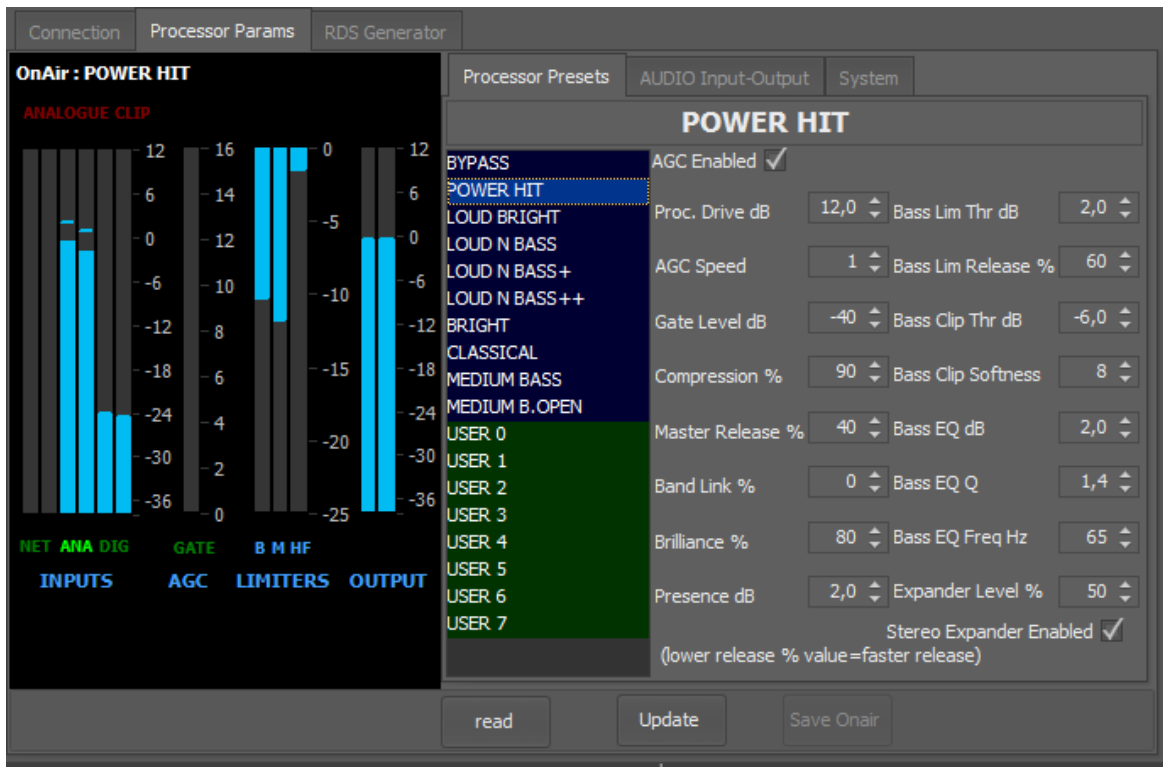

All presets are listed and, with a double click, is possible to recall a preset and put it on air. Factory presets are displayed in blue background, user definable presets in green and, in orange, a modified preset not yet saved.

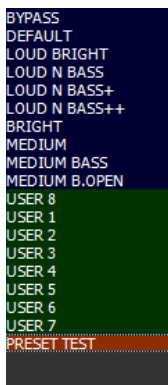

The modified preset (in orange) will be usable until a new preset is loaded and then modified.

On the same page are present the audio processing parameters. For a detailed description of each parameter, please refer to the audio processor section:

Processor Drive, Gate Level

AGC Enabled, AGC Speed

Compression, Master Release

Band Link, Brilliance, Presence

Bass Lim Thr, Bass Lim Presence, Bass Clip Threshold, Bass Clip Softness

Bass EQ, Bass EQ Q, Bass EQ Freq

Expander Level, Stereo Expander Enabled

Read: read the parameters setup from the processor

Update: send the modified audio processing parameters to the processor: when a factory or a user preset is modified, a temporary preset will be created. The **Save Onair** button will be enabled to save the preset once changes are terminated. The preset name can be directly changed in the preset name editor.

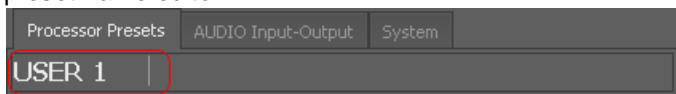

Then, pressing the **Save OnAir** button, it will be possible to select the destination user preset.

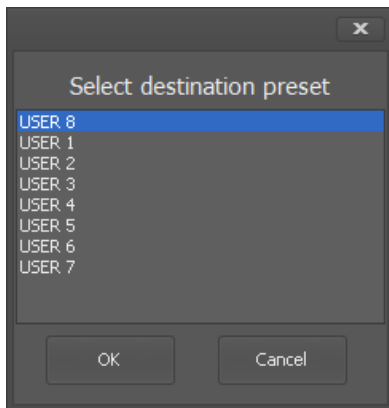

3.2.2 Audio input-output

This page allows for selection of on air audio input, changing audio output parameters, setting up the audio fallback and the source dependent presets.

The screenshot displays the 'OnAir : POWER HIT' interface. On the left, there is a level meter with four main sections: 'INPUTS' (NET, ANA, DIG), 'AGC' (GATE), 'LIMITERS' (B, M, HF), and 'OUTPUT'. The 'ANALOGUE CLIP' indicator is active. The right panel is titled 'AUDIO Input-Output' and contains the following settings:

- Audio Input: Analog input
- Source dependent presets:
- Analog In Level dB: 0,0
- Digital In Level dB: 0,0
- Bypass In Level dB: 0,0
- Network In Level dB: 0,0
- Analog Out Level dB: 0,0
- AES Out Level dB: -6,0
- Input 30Hz HPF:
- Audio Backup Enabled:
- Preset for analog: POWER HIT
- Preset for digital: POWER HIT
- Preset for network: POWER HIT
- Analog Output Mode: Clipped and filtered
- Analog Output Deemphasis: 50uS
- Audio Source 1: Analog input
- Audio Source 2: AES EBU
- Audio Source 3: AES EBU
- Alarm Timeout (S): 30
- Back Timeout (S): 120
- Alarm Threshold (dB): -40

At the bottom of the interface are three buttons: 'read', 'Update', and 'Save Onair'.

For a detailed description of the following parameters, please refer to [audio input setup](#), [audio output setup](#) and [source dependent presets](#)

[Audio Input, Analog InputLevel, Digital InputLevel, Network InputLevel
Bypass InputLevel
Audio OutputLevel
Audio Backup Enabled
Source dependents presets](#)

Input 30Hz HPF: enables / disables the 30Hz high pass filter for infrasonic component reduction.

Read: read parameters from the processor

Update: send changes to the processor

3.2.3 System setup

In this page it is possible to enable and adjust the optional RDS encoder carrier level, the pilot carrier, insert and adjust the network parameters.

The screenshot shows the 'System' configuration page of the DPRO3 FM Audio Processor. It features a spectrum analyzer on the left and a configuration panel on the right. The configuration panel includes sections for RDS settings and Network parameters. The RDS section has a checked 'RDS Enabled' box and several adjustable parameters. The Network section includes fields for IP address, mask, gateway, and port. At the bottom of the configuration panel are 'read' and 'Update' buttons.

The network parameters are related to the optional network module only. If the streaming module was installed, network configuration will be done through the web server of the module.

For a detailed description of the following parameters, please refer to [MPX output setup](#) and [System setup](#)

[RDS Enabled](#), [RDS level](#), [Pilot Level](#), [Pilot Phase](#), [Modulation](#), [Preemphasis](#), [MPX Output Level](#), [MPX Audio Level](#)
[NET IP](#), [NET MASK](#), [NET GATEWAY](#), [NET PORT](#)

Read: read parameters from the processor

Update: send changes to the processor

3.3 Loading and saving a preset

All the audio presets customized by the user can be saved in files, this preset can be transferred to another DPRO or saved in an external drive.

The remote control software allows to load and save the audio processing presets through the File>Processor menu:

Save Usr Presets to Disk

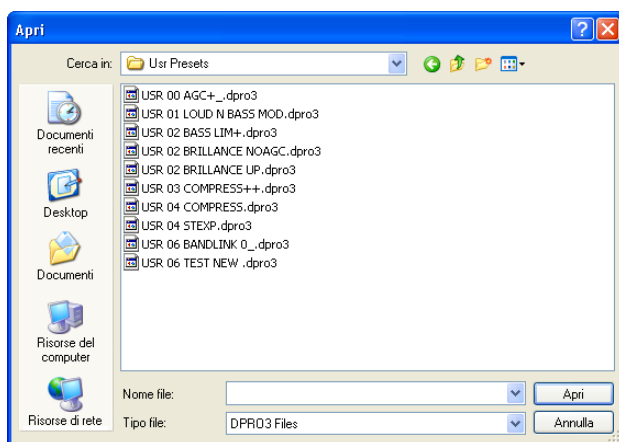
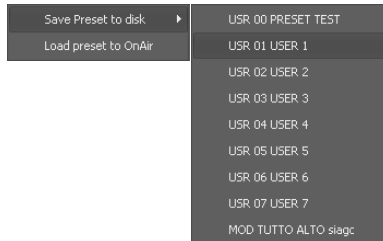

the on air preset will be saved to disk.

Load Usr Presets to Onair

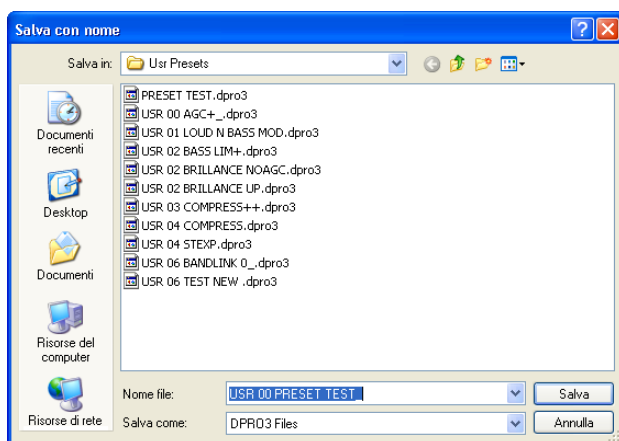
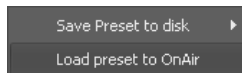

the preset loaded will be put on air.

3.4 Loading and saving system

The remote control software allows to load and save the system configuration through the "System" menu, and this includes all parameters listed under "System" and "Audio Input-Output" tabs.

Save System config to Disk

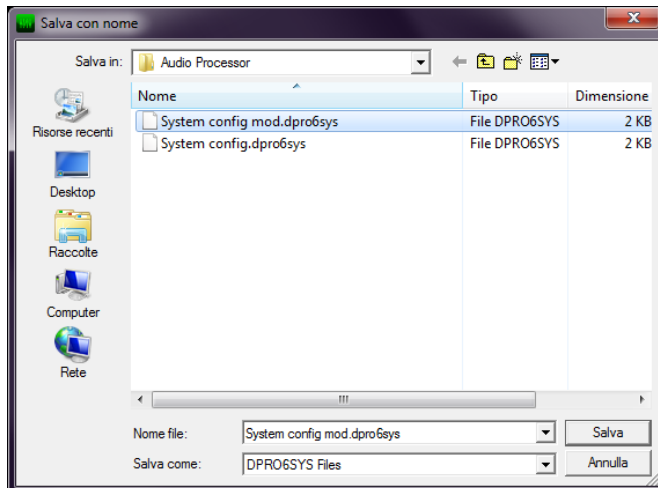
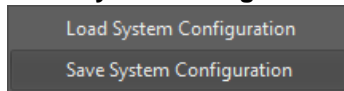

the system configuration will be saved to disk.

Load System config from Disk

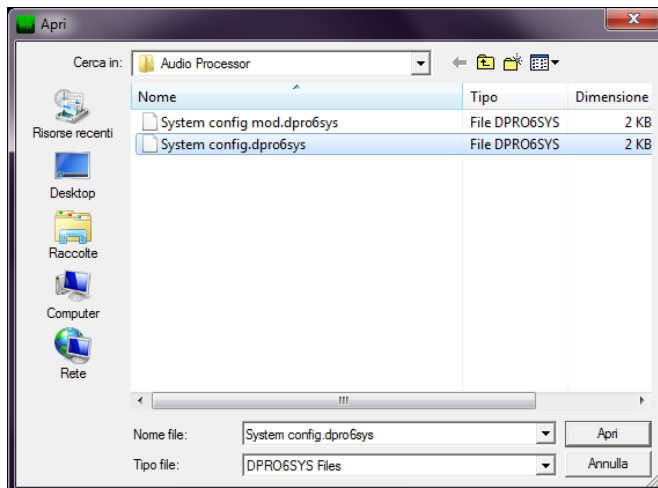
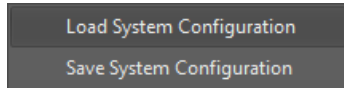

the system config preset loaded in.

3.5 RDS

RDS configuration pages will be visible only if the optional RDS coder was enabled.

3.5.1 RDS Flags window

The screenshot shows the 'RDS Flags' window with the following elements:

- Navigation tabs: Flags, PS, RadioText, AFList.
- Station ID: Text input field containing 'STATION NAME'.
- Program Type: Dropdown menu showing '09: Varied'.
- Country: Dropdown menu.
- Coverage: Dropdown menu.
- PI Code: Text input field containing '5230'.
- Checkboxes:
 - TA:
 - TP:
 - Music:
 - Artificial Head:
 - Compressed:
 - Enable Radiotext:
- Buttons on the right:
 - Current Page: Read, Write
 - All RDS parameters: Read Coder, Program Coder, Abort

This window contains the configuration parameters of the RDS encoder.

RDS ENABLED: enable RDS coder.

PTY: Program Type

Set the program type.

Many receivers are equipped to select the received stations based on the format preferred by the listener.

PI:Program Identification

Identification code of the station.

The code consists of 4 digits, the first digit indicates the country of origin, the second represents the area of coverage and the last two identify the station into its coverage area.

First digit, the country of origin of the program. You may write it directly into the "PI Code" editbox or select it using the "Country" dropdown list.

A list of some country codes is reported in appendix A.

For the second, according to the coverage area, choose one of the following codes:

0	local coverage, <i>the station is supposed to have one frequency only</i>
1	International coverage
2	National coverage

3	Supra-regional coverage
4..F	area codes for regional coverage stations

Note: the local coverage code "0" is intended for stations having one frequency only, so its use is intended just in this case. If the station has more than one frequency, a supra regional (3) or regional code (4 to F) must be used. Using the local coverage code (0), make many receivers to ignore the alternative frequencies tables.

The two last digits uniquely identify the station into its coverage area and shall be different amongst all other stations broadcasting over the same area.

Some examples:

5001: Italian radio station (5)	local coverage	(0),	program identifier code 01
5202: Italian radio station (5)	national coverage	(2),	program identifier code 02
54AF: Italian radio station (5)	regional coverage	(4),	program identifier code AF

TP: Traffic program

This flag indicates that your station, during normal programming, broadcasts traffic programs.

TA: Traffic Annonunce

Traffic Annonunce on air.

This flag should be set when traffic related news are being broadcasted.

For this reason, the TA flag can be switched by the external control port.

MUSIC: This flag indicates if the station main format is music or speech.

Some receivers use this information to apply a different tone equalization or volume according to whether music or speech is being broadcasted.

It is possible to switch this flag externally, using the external control port.

ARTIFICIAL HEAD: This flag indicates that the program was recorded using an artificial head.

This device is a dummy human head with two microphones inserted into the auditory canals, used during the recording process of the performance or live event, to accurately reproduce the original spatiality.

COMPRESSED: This flag indicates that the program was compressed.

ENABLE RADIOTEXT: Flag to enable radiotext group (2A) transmission.

If disabled, only OA groups will be trasmitted.

STATION ID: This 16-chars string can be assigned to the coder for its identification.

It could be its destination, the site to which the encoder is assigned, or the name of the radio which owns it.

It will not be shown anywhere else, neither transmitted into any RDS block; it is only a label to identify the processor.

3.5.2 PS window

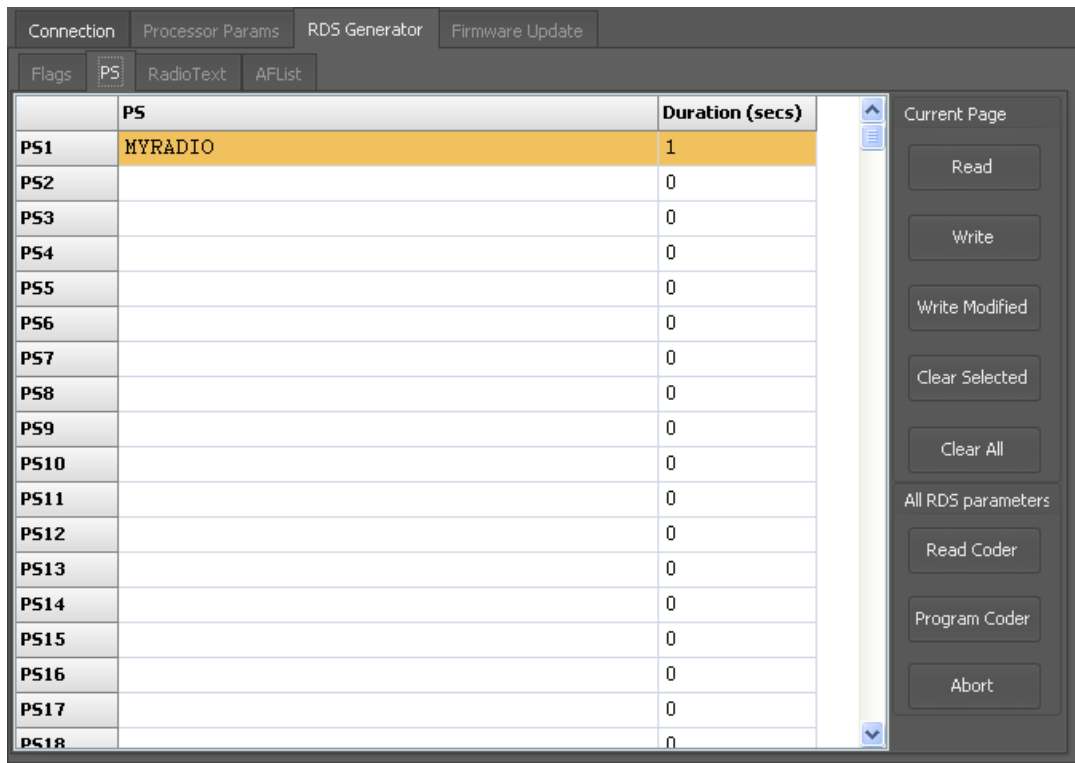

In this window, It is possible to enter the program station names, each of which can be up to 8 characters long.

For each string you can set the display duration time in seconds.

A duration time of 0, disables the corresponding string.

READ: read all PS strings from the encoder.

Warning: all strings on the grid will be overwritten.

WRITE:transfer all strings on grid to the coder.

Warning: the strings on the coder will be overwritten.

WRITE MODIFIED:transfer only modified entries

CLEAR ALL:clear all strings which are on the grid.

CLEAR SELECTED:clear all selected strings on the grid.

3.5.3 Radiotext window

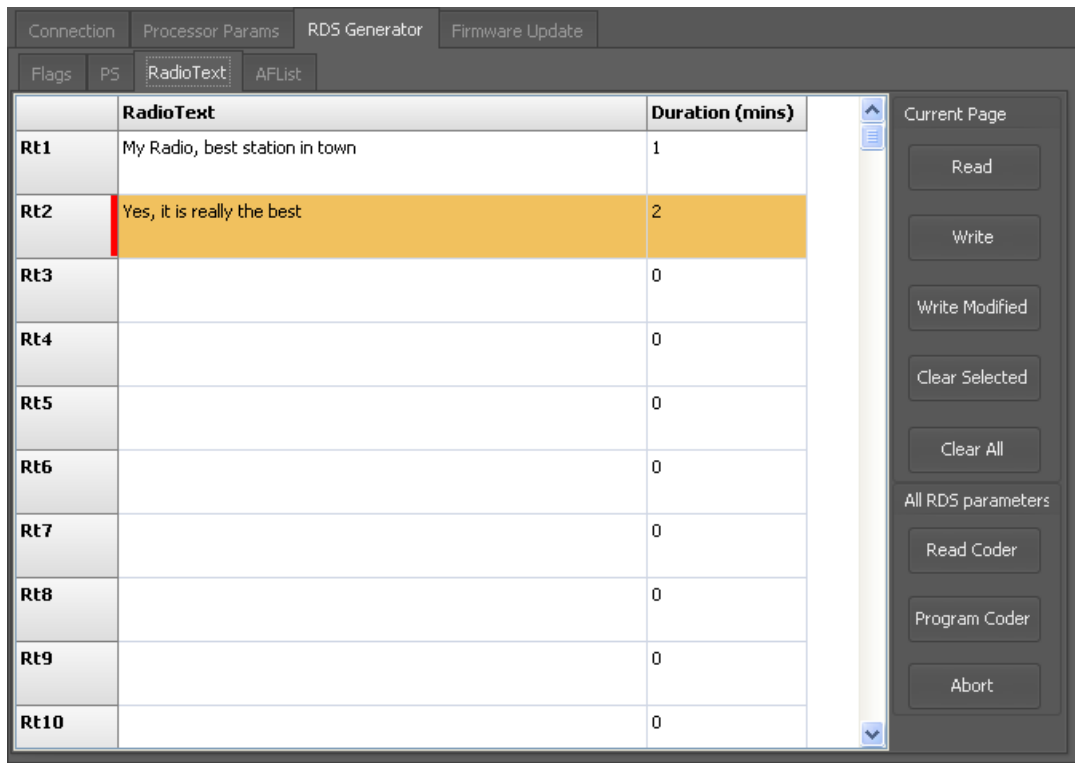

In this window, It is possible to enter the radiotext strings, each of which can be up to 64 characters long.

For each string you can set the display duration time in minutes.

A duration time of 0, disables the corresponding string.

READ: read all radiotext strings from the encoder.

Warning: all strings on the grid will be overwritten.

WRITE:transfer all strings on grid to the coder.

Warning: the strings on the coder will be overwritten.

WRITE MODIFIED:transfer only modified Radiotext entries

CLEAR ALL:clear all strings which are on the grid.

CLEAR SELECTED:clear all selected strings on the grid.

3.5.4 AF Lists window

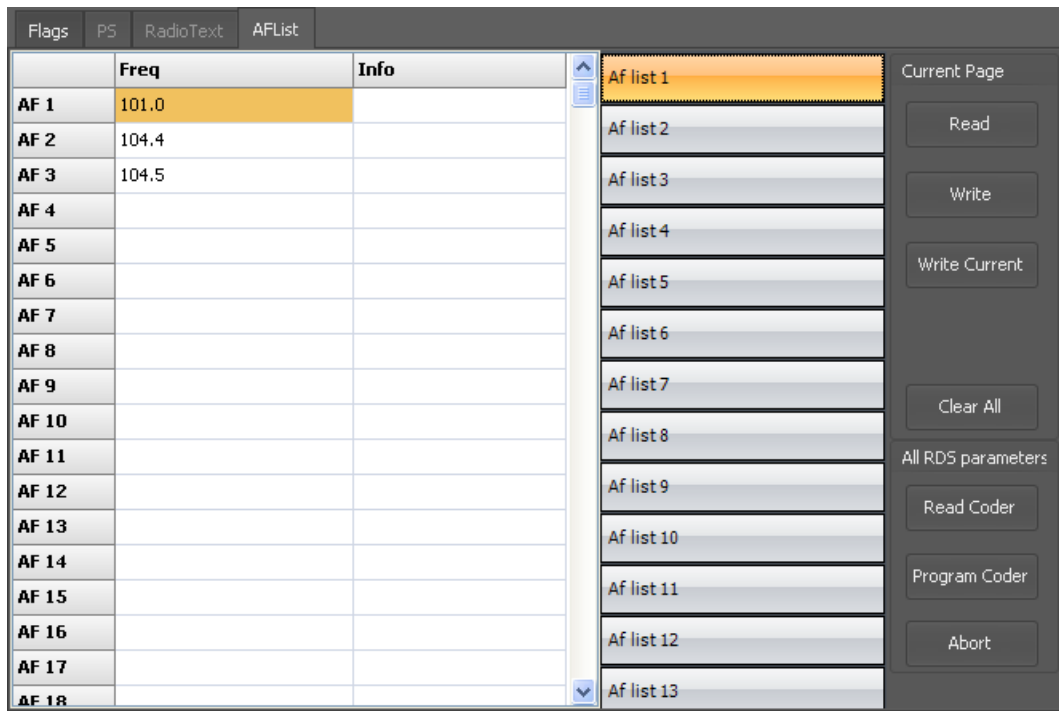

The RDS encoder allows for method "A" or "B" for alternative frequencies coding.

The choice between the two methods depends on the structure of the network and the number of alternative frequencies.

There is no flag which indicates if the alternative frequencies are transmitted by method "A" or "B": the difference between the two methods is encoded in the way the frequencies are disposed into the list.

Notes:

It is not possible to compile different lists using the A and B simultaneously.

"A" method should be used only when the network has a maximum of 25 frequencies and does not differentiate regional programming.

"B" method is used when the alternative frequencies are more than 25 or when, within the same network, there is a program differentiation, such as local news or advertising, only on certain frequencies.

The lists must be compiled starting from the first and should be filled leaving no empty lists in between: any empty list will be automatically removed upon coder programming.

3.5.4.1 Editing

AF	Freq	Info
AF 1	101.0	
AF 2	104.4	
AF 3	104.5	
AF 4		
AF 5		
AF 6		
AF 7		
AF 8		
AF 9		
AF 10		
AF 11		
AF 12		
AF 13		
AF 14		
AF 15		
AF 16		
AF 17		
AF 18		

The frequencies must be inserted starting from the first list “Af list 1”, cell AF1.

Right-clicking on the list, a popup menu will appear allowing to:

Clear list: the current list will be cleared

Sort frequencies: the frequencies inserted into the current list will be sorted in ascending order

Insert: insert a new frequency at the selected cell position

Remove: remove the frequency at the selected cell position

3.5.4.2 A Method

This is the simplest method and it is indicated for all those stations which have a maximum of 25 alternative frequencies and do not provide regional - differentiated programming.

To implement this method, simply insert in AF List 1 all frequencies of the station in ascending order.

No other list must be filled.

Example:

88.1

91.3

104.1

104.5

3.5.4.3 B Method

This method is used where the number of alternative frequencies used in a network exceeds 25, or where it is required to indicate frequencies which belong to different areas which at times carry different programs.

Each transmitter and associated repeater stations broadcast the same set of different AF lists in sequence.

The number of AF lists within a network is in general identical to the number of transmitters and repeater stations in the network so as to provide a unique list for each transmitting station. In this protocol the alternative frequencies for the VHF/FM transmitters are individually addressed by transmitting the tuning frequency paired with one alternative frequency within one block.

Each list starts with the tuning frequency for which the list is valid.

All remaining pairs (up to 12) give the tuning frequency together with a valid AF.

Usually, the tuning/AF pair has to be entered in ascending order if the AF is not a regional variant of the tuning frequency, on the contrary the order has to be reversed.

If the number of AFs of a station is larger than 12, the list must be split into two or more lists. These lists are transmitted directly one after the other, and the receiver must combine the lists again.

If a transmitter frequency is used more than once within a network the respective AF lists are transmitted separately. In order to indicate that these lists with the same tuning frequency belong to different stations, the lists must be separated by AF lists of other stations.

To simplify the programming of a B list, put into the first line AF1 the main tuning frequency, then enter on the other lines (AF2 to AF13) a maximum of 12 alternative frequencies, then press the button "Build B list."

If you, in future, wish to add some new frequencies to the list, simply enter them at the bottom and press the button "Build B list again."

Flags	PS	RadioText	AFList
	Freq	Info	
AF 1	90.0		Af list 1
AF 2	104.5		Af list 2
AF 3	93.5		Af list 3
AF 4	105.2		Af list 4
AF 5	106.7		Af list 5
AF 6	104.9		Af list 6
AF 7			Af list 7
AF 8			Af list 8
AF 9			Af list 9
AF 10			Af list 10
AF 11			Af list 11
AF 12			Af list 12
AF 13			Af list 13
AF 14			
AF 15			
AF 16			
AF 17			
AF 18			

Flags	PS	RadioText	AFList
	Freq	Info	
AF 1	90.0		Af list 1
AF 2	104.5		Af list 2
AF 3	93.5		Af list 3
AF 4	105.2		Af list 4
AF 5	106.7		Af list 5
AF 6	104.9		Af list 6
AF 7			Af list 7
AF 8			Af list 8
AF 9			Af list 9
AF 10			Af list 10
AF 11			Af list 11
AF 12			Af list 12
AF 13			Af list 13
AF 14			
AF 15			
AF 16			
AF 17			
AF 18			

Current Page

Read

Write

Write Current

Clear All

All RDS parameters

Read Coder

Program Coder

Abort

The main frequency (90.0MHz) is put in the first AF cell (AF1) and all alternatives are following from AF2 to AF6.

Flags	PS	RadioText	AFList
	Freq	Info	
AF 1	90.0	Main Freq	Af list 1
AF 2	90.0	Main Freq	Af list 2
AF 3	93.5		Af list 3
AF 4	90.0	Main Freq	Af list 4
AF 5	104.5		Af list 5
AF 6	90.0	Main Freq	Af list 6
AF 7	104.9		Af list 7
AF 8	90.0	Main Freq	Af list 8
AF 9	105.2		Af list 9
AF 10	90.0	Main Freq	Af list 10
AF 11	106.7		Af list 11
AF 12			Af list 12
AF 13			Af list 13
AF 14			
AF 15			
AF 16			
AF 17			
AF 18			

Flags	PS	RadioText	AFList
	Freq	Info	
AF 1	90.0	Main Freq	Af list 1
AF 2	90.0	Main Freq	Af list 2
AF 3	93.5		Af list 3
AF 4	90.0	Main Freq	Af list 4
AF 5	104.5		Af list 5
AF 6	90.0	Main Freq	Af list 6
AF 7	104.9		Af list 7
AF 8	90.0	Main Freq	Af list 8
AF 9	105.2		Af list 9
AF 10	90.0	Main Freq	Af list 10
AF 11	106.7		Af list 11
AF 12			Af list 12
AF 13			Af list 13
AF 14			
AF 15			
AF 16			
AF 17			
AF 18			

Current Page

Read

Write

Write Current

Clear All

All RDS parameters

Read Coder

Program Coder

Abort

Right click on the list and select the "Build B List" command: the list will be compiled using "B" method.

3.5.5 Loading and saving RDS coder configuration

The remote control software allows to save and reload a complete RDS coder configuration through the File>RDS menu:

Load Configuration

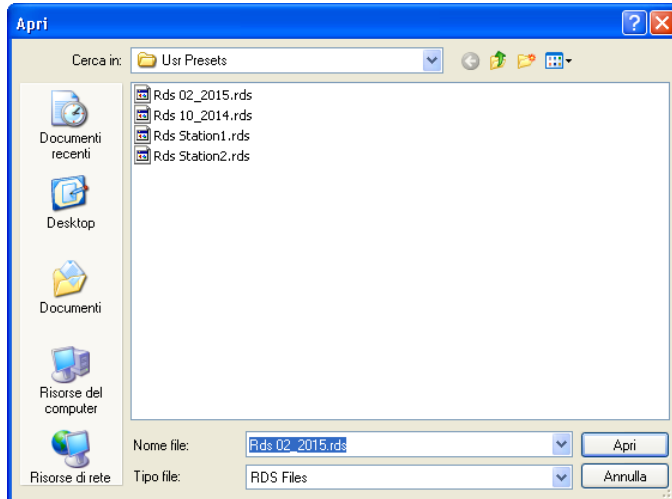
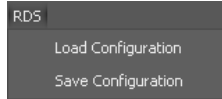

Save Configuration

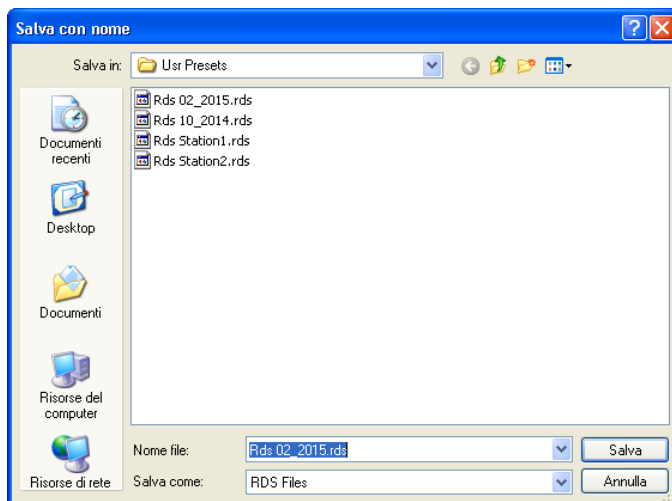
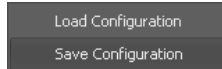

The *.rds file will contain the whole RDS encoder configuration, it can be stored as a backup or used to transfer the configuration to other devices.

3.6 Passcode setup

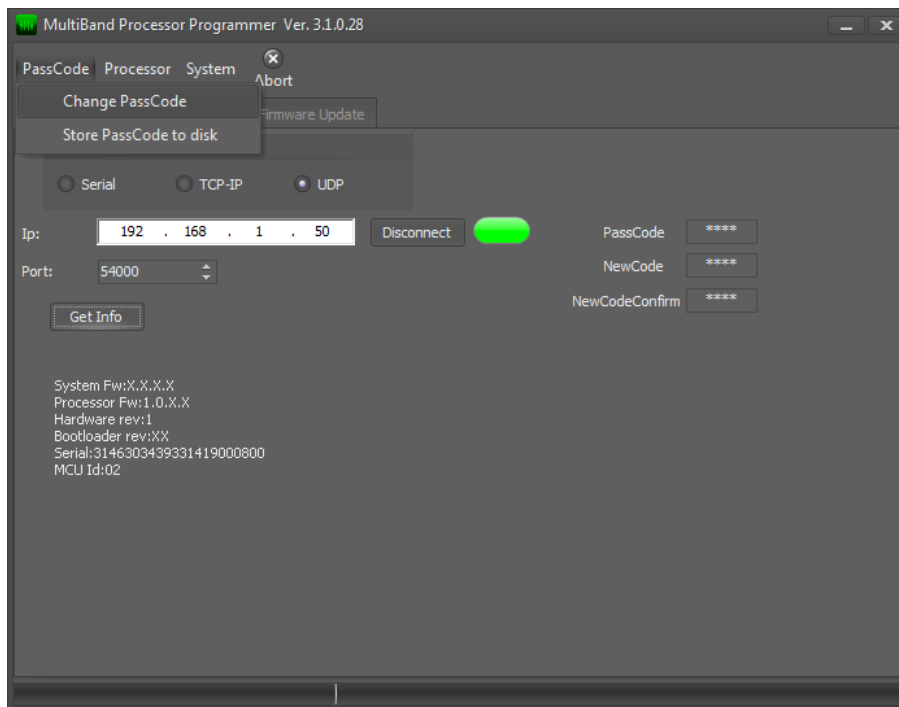

To protect the device from unauthorized operation, a security code can be set. The default code is 0000 (security disabled), but it can be changed through the following procedure:

Put the current Passcode into the PassCode edit box (0000 by default).
Put a new code into the "New Code" and, the same again, into the "New Code Confirm" editor.
Go to Menu->PassCode->**Change Passcode**

The user will be prompted for passcode change confirmation, then the passcode will be changed.

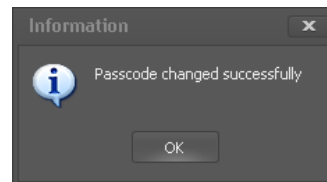
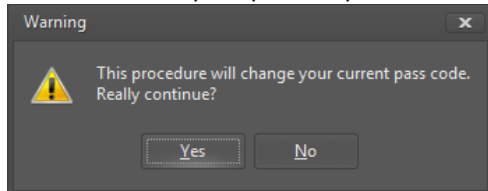

Store Password to disk: store the current passcode to not enter it each time the program is used.

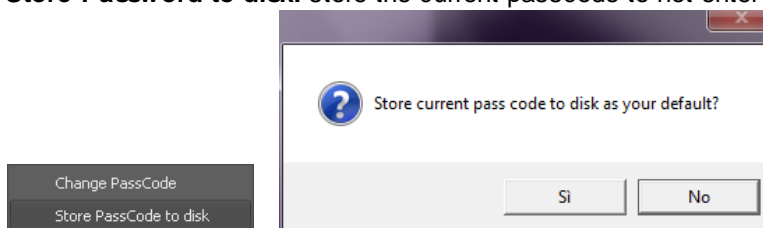

Section

RD Link

4

4 RD Link

RD-Link is a software which allows the connection of the RDS coder to the radio automation system to allow for dynamic radiotext and radiotext Plus, TA and Clock-Time to be implemented.

At the time of writing this document, the software is already compatible with several radio automation systems, but other interfaces may be included on customer request in order to extend the compatibility to other systems.

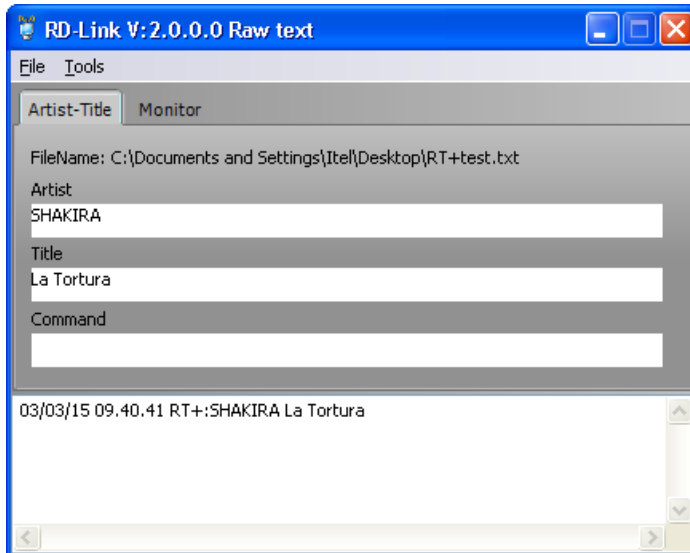

4.1 Radiotext Plus

Radio text plus is a complementary service that, united with classic radiotext, enables tagging of specific radiotext parts so that they can be isolated and used by some specialized receivers. You can then, for example, have the complete station playlist aired for the listening period.

An example of normal radiotext tagged with radiotext plus (RT+).

The normal radiotext carries the string: "SHAKIRA - La tortura"



A receiver with Radiotext Plus decoding capabilities will "know", for example, which part of the whole text is the artist's name and which is the song title.

In this case, the song title and artist's name are used to compile the playlist aired by the station we are listening.

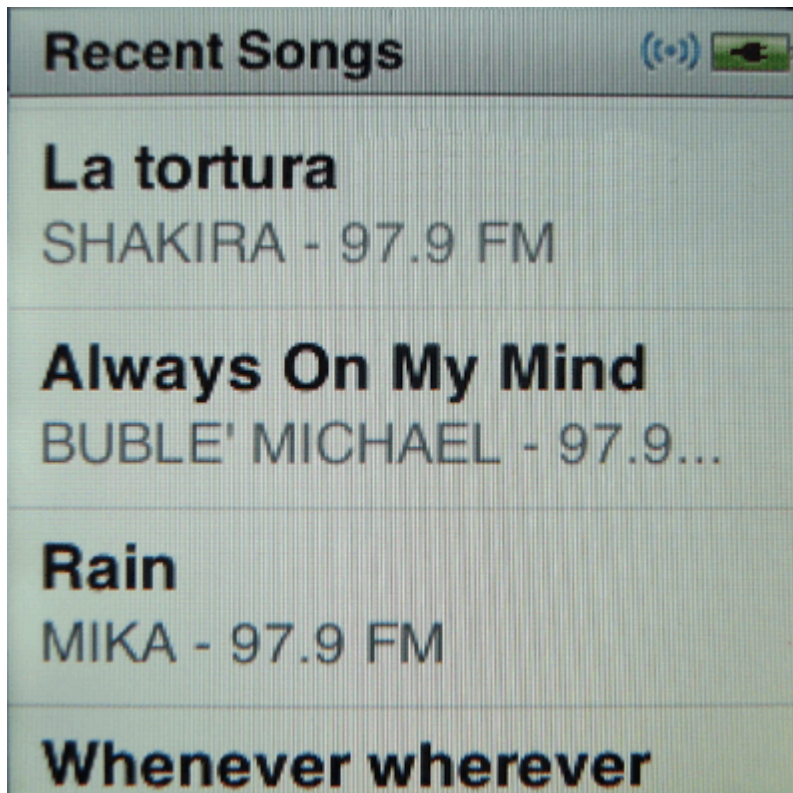

In the case below, the radiotext string is "You are listening to Shakira with La tortura Feat. Alejandro Sanz" and both normal radiotext and tagged radiotext are shown: first string is the artist name, the second is the song title, last string is the normal radiotext.



4.2 Monitor

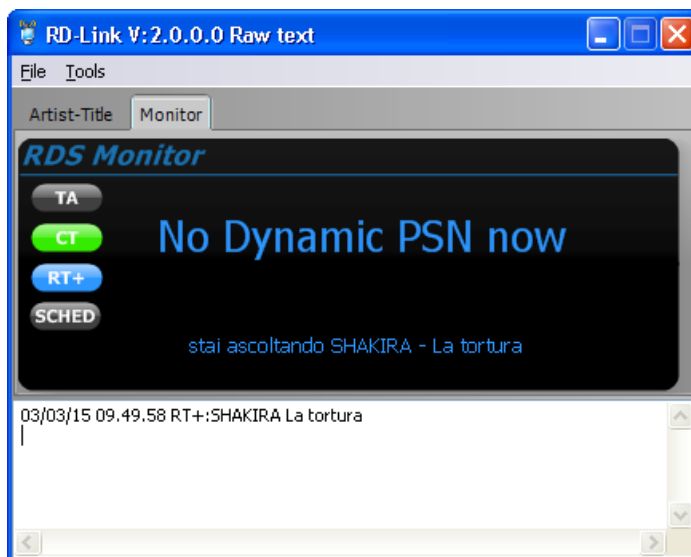

On the **Monitor** window the dynamic PS and Radiotext strings are shown in the same way as they are being transmitted.

It is shown also the status of TA,CT, RT+ flags and scheduler.

- | | |
|-----------|---|
| TA | Orange : TA flag active during traffic news on air.
Gray: TA flag disabled |
| CT | Green: transmission of Clock/Time block 4A, for remote clock visualization and synchronization, is enabled
Gray: CT is disabled. |

-
- RT+** Blue: the radiotext string actually shown is tagged using radiotext plus.
Gray: Radiotext Plus is disabled.
- SCHED** Green:scheduler is enabled, Radiotext Plus is enabled
Red:scheduler is enabled, but actually Radiotext Plus is disabled by the scheduler
Gray: scheduler disabled, Radiotext plus tagging is controlled by the flag [Enable RT](#)

4.3 Configuration

Open configuration menu (**Tools->Configuration**), and the following window will appear:

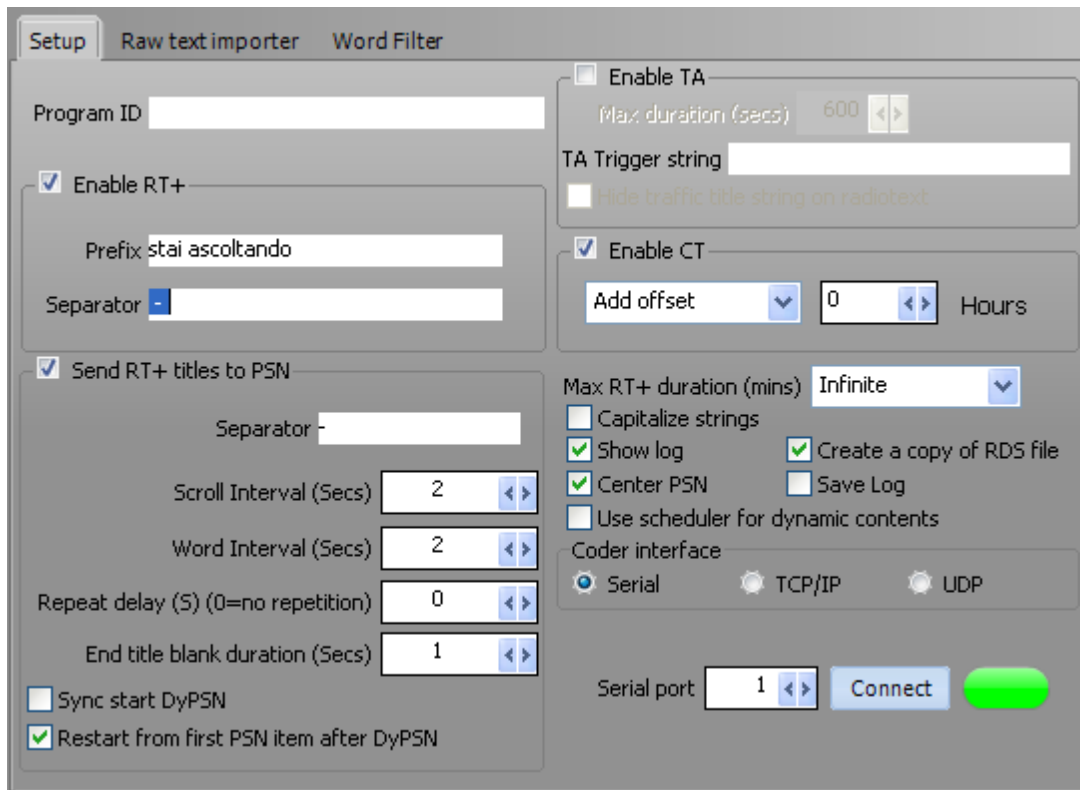

4.3.1 Setup

4.3.1.1 Program ID

It is possible to assign a name to the executable window in order to recognize it quickly, when multiple executables are running at the same time to control different coders (eg different programs belonging to the same publishing group).

4.3.1.2 Radiotext Plus and dynamic PSN

Enable RT +: Enable radiotext plus

The strings sent by radio automation system will be passed to radiotext only if this flag is enabled. You can also add a prefix and a separator to the string which will be put on-air. Please note that the maximum length of radiotext string in block 2A, is 64 characters. If the total length of the string, including prefix and separator, will be longer than this limit, it will be truncated automatically.

Send RT + titles to PSN: Enable sending radiotext titles on PSN.

With this function, the song titles will also be sent on the PSN (maximum length is 8 characters). This function should be used with caution as it can cause driver distraction and in some countries is expressly prohibited. You are advised to check your local regulations before to activate it.

To limit driver distraction, single character scrolling has been reduced to a minimum, as the program tries to convey mainly whole 8 characters blocks.

Separator: separator to be inserted between title and artist. A different separator can be chosen with respect the one used for radio text.

Scroll interval (secs): scroll time interval of a single character.

All strings which will not fit 8 characters, will be displayed by scrolling one character at a time using this interval.

Word interval (secs): display time of a single word.

A word which has a length less than or equal to 8 characters, will be displayed for the time selected.

Repeat delay (secs): The title will be displayed again on the PSN , after this time (in seconds) is elapsed. If the entered value is 0, the title will be displayed once at the beginning of the new song, then the coder will send the PSN strings stored internally until the next song.

End title blank duration (secs): if set to any value other than 0, an empty PSN will be displayed for the selected duration, once the dynamic PSN is ended and before to putting on-air the internal PSN strings.

Sync start DyPSN: if enabled, it will start the dynamic PSN only at the end of the internally stored strings.

Eg internally stored strings are:"MY RADIO", "THE BEST", "IN TOWN" (loop).

Without Sync Start: "MY RADIO", "**BEATLES**", "**HELP**", "THE BEST", "IN TOWN", "MY RADIO", "THE BEST", "IN TOWN"(loop) (dynamic PS strings are bolded).

With Sync Start: "MY RADIO", "THE BEST", "IN TOWN", "**BEATLES**", "**HELP**", "MY RADIO", "THE BEST", "IN TOWN"(loop) (dynamic PS strings are bolded).

Restart from first PSN item after DyPs: if enabled, after a dynamic PSN is transmitted, it will restart the display of internal strings from the beginning.

Eg internally stored strings are:"MY RADIO", "THE BEST", "IN TOWN" (loop).

Without restarting: "MY RADIO", "**BEATLES**", "**HELP**", "THE BEST", "IN TOWN", "MY RADIO", "THE BEST", "IN TOWN"(loop) (dynamic PS strings are bolded).

With restarting: "MY RADIO", "**BEATLES**", "**HELP**", "MY RADIO", "THE BEST", "IN TOWN"(loop) (dynamic PS strings are bolded).

4.3.1.3 TA - Clock time

Enable TA: the TA flag will be switched on during traffic news.

Max duration: maximum traffic news duration. Once this time is elapsed, the TA flag, if it was previously set on, will be automatically switched off.

TA Trigger string: it is the name, as passed to the program by the radio automation system, of the traffic news audio file. If traffic news are live, this could be the name of the file used as traffic news liner. The name is case insensitive.

Hide traffic title string on radiotext: if enabled, it will not send the string associated with the traffic news file to radiotext or PSN.

Enable CT: enable sending CT (clock time).

Enabling this function, it will be sent the 4A block for radio alarm clocks synchronization and date-time visualization.

As the PC system clock will be used, it is recommended to keep the system clock synchronized using any time server.

The 4A block transmission will be suspended when PC is shut off or the PC-Coder communication is broken.

Add offset: offset for the time currently sent.

4.3.1.4 Communication interface and additional settings

Max RT Duration: maximum radiotext duration.

This control sets the maximum time for the same Radiotext Plus string visualization. If this period is exceeded, the coder will start to send the internally stored RT strings, returning to dynamic RT+ once a new string is received.

Show log: show program activity log.

Center PSN: auto center the strings displayed on PSN, if they are shorter than 8 characters.

Use scheduler for dynamic contents: enable scheduler for dynamic radiotext plus and PSN activation, if they are supposed to be active only on some week days or at a specified time,

Create a copy of RDS file: creates an identical copy of the title file written by the automation system to be read by other applications (eg: streaming encoder).

Save log: save a daily program activity log on a file eg: "log_18-06-2014.txt"

Coder interface: communication interface selection, RS232, TCP/IP or UDP.

4.3.2 Raw Text Importer

Raw text importer allows to read plain text files generated by the radio automation system.

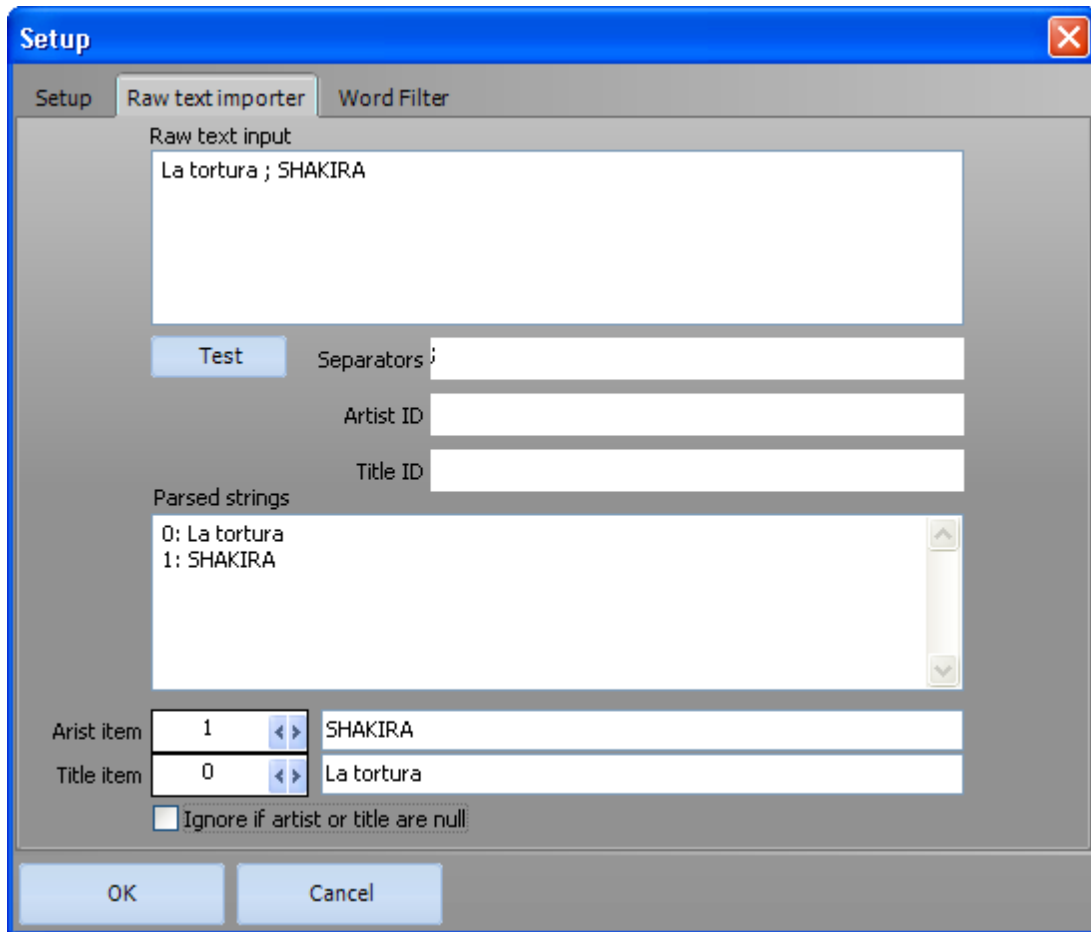

The contents of the currently selected file (from the main window menu **File-> Raw TextFile**) is displayed in the **Raw Text Input**.

The artist and title fields may be separated in two ways:

using separators: the strings read from the file will be divided using the characters entered in the "Separators" editor.

In the above example, the input string "SHAKIRA;La tortura" is divided, using the separator ";".

This will produce two output lines (line 0:La tortura, line 1: SHAKIRA).

Then, using the controls "Artist item" and "Title item", set which line must be used as title and which one as the artist name.

using identifiers eventually included in the raw file: if the raw file was already marked with labels such as:

CurrArtist = Michael Jackson

CurrTitle = Thriller

you can simply enter in the editors "Artist ID" and "Title ID" the two identifiers "CurrArtist =" and "CurrTitle =" (without quotes).

The program will then automatically isolate strings related to artist name and song title.

In both cases, pressing the "Test" button, the user will be able to experiment with different settings of indexes, separators or identifiers.

If the checkbox "Ignore if artist or title are null" is checked, all items having no artist name or title will be discarded.

This feature, combined with the word filter, avoids to display jingles titles, backing tracks and everything else that must not appear in the dynamic radiotext.

4.3.3 Word filter

Word filter avoids the visualization, on dynamic radiotext and PS, of all strings which match any word in list.

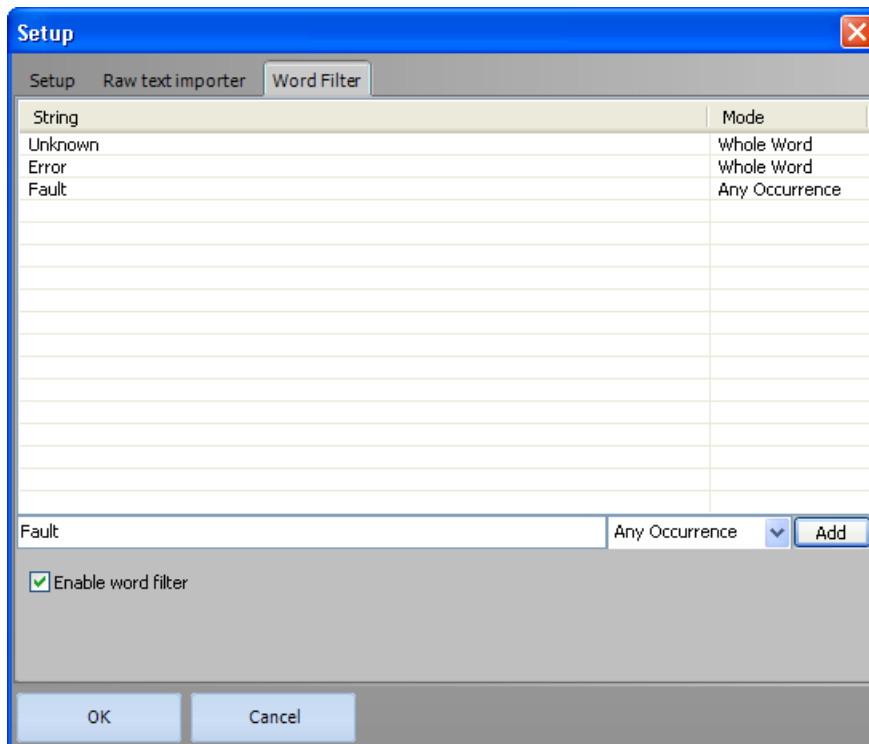

Words are added writing them in the editing line, then must be set the recognition method (Whole Word or Any Occurrence). Pressing the "Add" button, the new word will be added to the list.

Whole word: the word to be recognized must be correspond exactly to the input string:

Example, filter word "**apple**": "**apple**" is recognized and filtered, "**pineapple**" is not recognized.

Any Occurrence: any occurrence of the filter word is recognized:

Example, filter word "**wide**": "**wide**" is recognized and filtered, but also "**widescreen**" or "**worldwide**".

Words are always compared in case-insensitive mode: setting a filter for word "Test", "TEST" or "TeSt", will result in the same effect.

4.4 Scheduler

The dynamic content scheduler (**menu Tools->Scheduler**) allows to activate the Radiotext Plus and dynamic PSN only in predetermined time intervals.

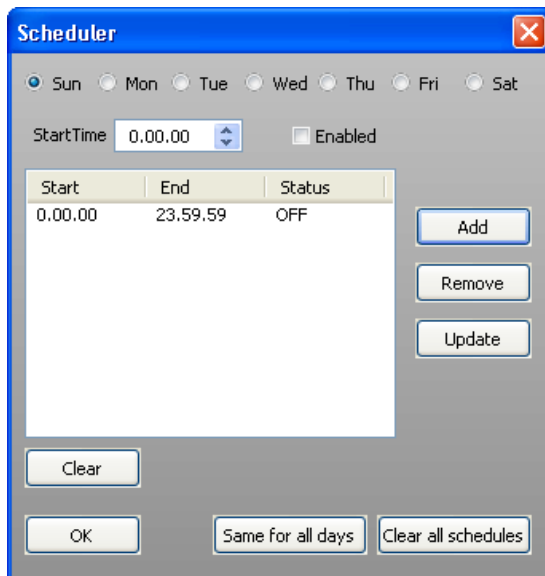

For example, we want to use dynamic RT+ and PSN only from 8.00 to 12.00 and from 18.00 to 23.00 every day except on Sundays where it will be active for the entire day.

So an event must be created, scheduled for 8:00 am (set into "**Start Time**" box), having "**Enabled**" status checked.

Pressing the "**Add**" the button, the event will be added to the events list.

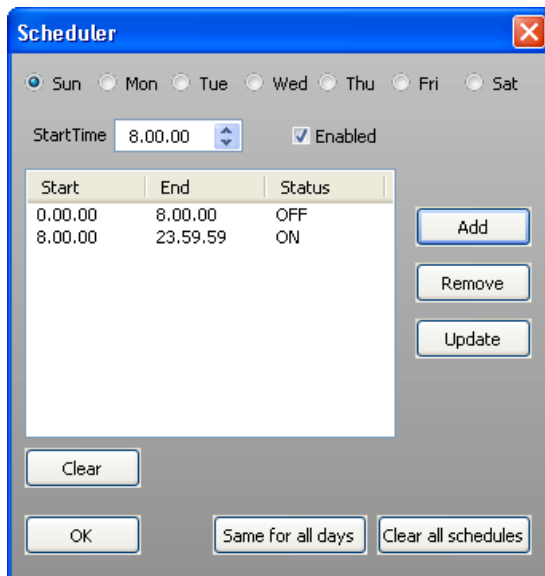

We have that the dynamic content will be disabled from 00.00 to 8.00 then, for the event we created, from 8.00 onwards it will be enabled.

Now the dynamic content disabling event should be added: put 12:00 into the "**StartTime**" box, uncheck the "**Enabled**" checkbox and push "**Add**" button.

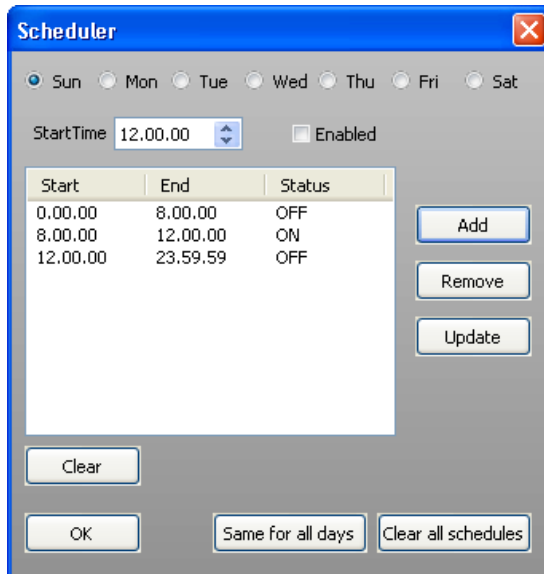

The dynamic content has to be re-enabled from 18:00 to 23:00, so one enabling event has to be added at 18:00 and a disabling event at 23:00. In the following picture is represented the complete programming.

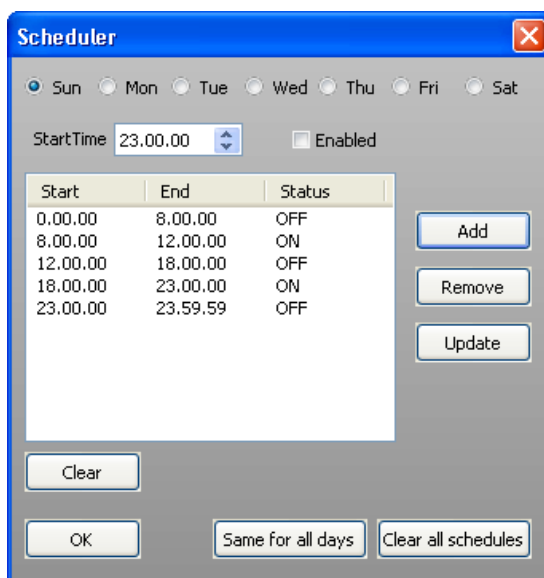

Summarizing: firstly the dynamic content enabling was added at 8:00hr, then the disabling event at 12:00hr, the re-enabling at 18:00hr and the disabling at 23:00hr. Since this scheduling will be the same for almost the whole week, it can be simply copied to the other days, pressing the **"Same for all days"** button.

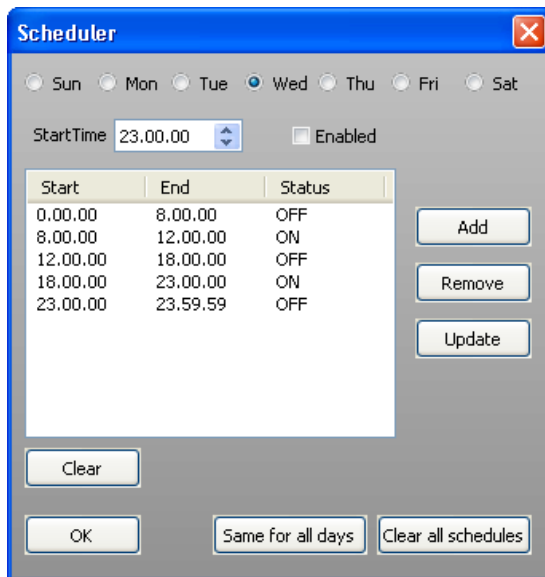

Once copied, it can be verified that, changing the week day selection at the top of the window, the scheduling is the same for all days.

Done this, you will then modify the Sunday scheduling only, where the dynamic content will be enabled for the whole day.

Select the week day, on the top of the window, "**Sun**"

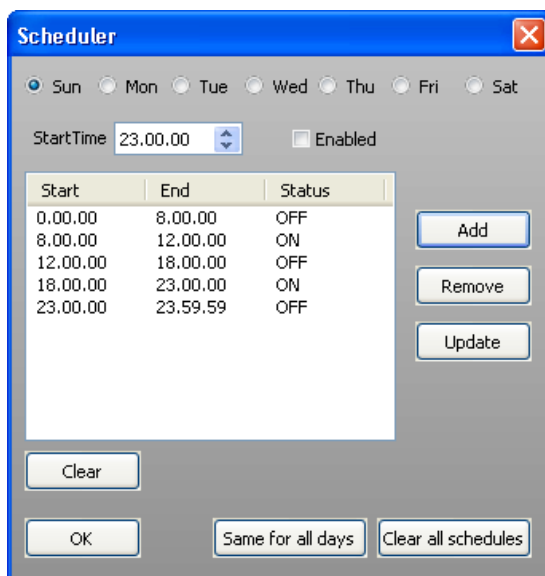

Press the "**Clear button**" to delete all scheduler entries for the current day.

Once all entries have been deleted, just add an event starting at 00:00, with "**Enabled**" checkbox checked to enable the dynamic content .

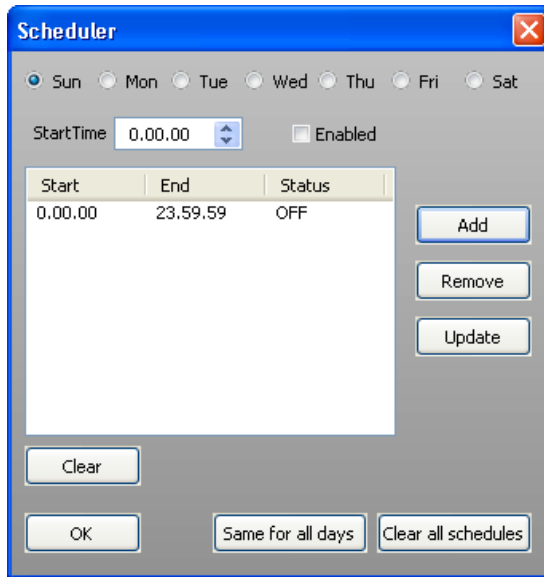

Programming is completed. Press "**OK**" button to save and exit from the current window.

Follows a short description of the other controls on the window:

Remove: removes the currently selected entry

Update: updates the currently selected entry with new time and/or status informations.

Clear all schedules: deletes all entries over all days.

Section

Streaming audio module

5

5 Streaming audio module

The module adds audio streaming decoding or encoding capabilities for receiving or transmitting streaming HLS / MP3 / AAC + shoutcast servers by HTTP/HTTPS using TCP / IP connectivity. The audio output is transferred in digital format to audio processor / stereo encoder, thus achieving the highest audio quality.

5.1 Decoder audio Stream

Connect the apparatus to your LAN and turn it on. Open a web browser on a PC from which the apparatus can be reached and type on the web browser's address bar: <http://192.168.1.100>. The audio module internal webserver should then load the login default page.

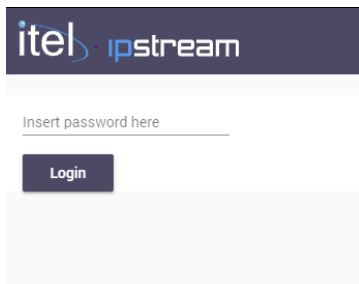

No password set by default, click on the login button and enter the main page.

Go to the "Streaming settings" menu and set one or more URLs from which to receive the audio stream.

Save current configuration by pressing the "Apply settings" button.

The module adds audio streaming decoding capabilities for receiving streaming MP3 / AAC + / HLS shoutcast servers or by using TCP / IP connectivity.

The audio output is transferred in digital format to audio processor / stereo encoder, thus achieving the highest audio quality.

An helpful guide for all settings appears on the side of the configuration page.

On the audio processor, now select the audio input "[NetAudio](#)" and the streaming audio received by the module should be put on-air.

Adjust, if necessary, the input level of audio input "netaudio." If you intend to use any audio processing during streaming audio playback, this setting can also be omitted since the processor will provide for automatic leveling.

The preset for the network input can be chosen into the [next window](#), after "netaudio" input has been selected into the current.

If you want to use more than a single audio source, for using the integrated automatic audio fallback, proceed to its selection and its associated audio processing preset.

Finally, turn the [audio fallback](#) on.

5.1.1 Status



In the Status section you can see the page relating to streaming decoding, network settings, system information and event logs.

Streaming Status

Network Status

System Status

System Log

Main stream:Connected

http://ice03.fluidstream.net/onedancech.mp3

Back stream:Disconnected

http://none

On Air stream:

http://ice03.fluidstream.net/onedancech.mp3

L Level: -0.1 dB

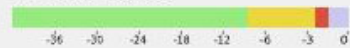

R Level: -0.1 dB



Buffer Level: 74

**Metadata**

Feel It - FPI Project

Streaming Status

This page displays audio decoding information, which URL is currently broadcast, audio levels, buffer status, and decoding metadata (if any).

On Air Stream: Describes which URL is currently decoded, if "Playlist" is displayed it means that the player is playing the files present in the memory unit applied to the rear USB DRIVE port.

Streaming Status	Network Status	System Status	System Log
------------------	-----------------------	---------------	------------

Mode:
Fixed IP Mode

Ip Address:
192.168.1.100/24

Gateway:
192.168.1.254

DNS Address:
8.8.8.8

Network Status

The network settings are listed here, the address page can also be viewed from the front display, System menu, Ethernet Settings page.

Streaming Status	Network Status	System Status	System Log
------------------	----------------	----------------------	------------

Firmware:
[1.7.0.2]

Frontend:
0.4

Uptime:
up 2 days, 14 hours, 35 minute

Ethernet Mac Address:
00:08:e1:08:33:97

GMT Offset:
1

System Status

The page contains information relating to the firmware version, Mac address, geographical area and

the uptime counter.

Streaming Status Network Status System Status **System Log**

System Log

- [23/02/2022 10:52:38 Local] --> System started
- [23/02/2022 10:54:45 Local] --> Logged in from web
- [23/02/2022 10:52:38 Local] --> System started
- [23/02/2022 10:52:38 Local] --> System started
- [23/02/2022 10:52:38 Local] --> System started
- [23/02/2022 10:52:38 Local] --> System started
- [23/02/2022 10:53:59 Local] --> Logged in from web
- [23/02/2022 10:54:12 Local] --> Ethernet settings changed
- [23/02/2022 10:54:18 Local] --> Main stream url changed
- [23/02/2022 10:54:18 Local] --> Backup stream url changed
- [23/02/2022 10:54:20 Local] --> Main stream Disconnected
- [23/02/2022 10:54:20 Local] --> Backup stream Disconnected
- [23/02/2022 10:54:25 Local] --> Main stream Connected
- [23/02/2022 10:54:30 Local] --> Main stream url changed
- [23/02/2022 10:54:30 Local] --> Backup stream url changed
- [23/02/2022 10:55:01 Local] --> Logged in from web

System Log

System events are stored sequentially in this Log page where they can be consulted for possible verification.

5.1.2 Streaming settings

Streaming settings

The following section allows you to enter the URL addresses to decode, you can enter a main URL and a backup URL in case the first one fails.

Streaming Settings

Main Stream

Backup Stream

Route Metadata to RadioText

Main Stream: Main streaming URL address

Backup Stream: Secondary or backup streaming URL address

Route Metadata to RadioText: Send the content of the metadata contained in the streaming to the RDS coder in RadioText (if option present and enabled), for management of the RDS coder see the dedicated paragraph.

Save and apply HTTP Stream Setting: Save your page changes

Reboot: Restarts the stream module.

5.1.3 Network settings

↔ Network Settings

On the following page you set the connection mode and network addresses.

Ethernet Settings Dhcp Mode
 Fixed IP Mode

Network IP Address
192.168.1.100/24

Network Gateway Address
192.168.1.254

Network Dns Address
8.8.8.8

Save Ethernet Setting

Ethernet Settings:

Dhcp Mode: IP automatic assignment mode in the presence of Dhcp servers on the network, if DHCP mode is selected, any IP address written in the fields below will be ignored.

Fixed IP Mode: How to set a static IP address, the network address must be provided in CIDR notation, i.e. A.A.A.A / XX, where XX is the netmask of the network.

Network IP Address: IP address assigned to the stream module.

Below is a netmask conversion table from decimal notation to CIDR.

CIDR DECIMAL

/1 128.0.0.0
/2 192.0.0.0
/3 224.0.0.0
/4 240.0.0.0
/5 248.0.0.0
/6 252.0.0.0
/7 254.0.0.0
/8 255.0.0.0
/9 255.128.0.0
/10 255.192.0.0
/11 255.224.0.0
/12 255.240.0.0

/13 255.248.0.0
/14 255.252.0.0
/15 255.254.0.0
/16 255.255.0.0
/17 255.255.128.0
/18 255.255.192.0
/19 255.255.224.0
/20 255.255.240.0
/21 255.255.248.0
/22 255.255.252.0
/23 255.255.254.0
/24 255.255.255.0
/25 255.255.255.128
/26 255.255.255.192
/27 255.255.255.224
/28 255.255.255.240
/29 255.255.255.248
/30 255.255.255.252
/31 255.255.255.254
/32 255.255.255.255

Network Gateway Address: Gateway IP address.

Network DNS Address: IP address of the domain name server.

5.1.4 System settings

System Settings

On the system page we find a string where we can assign a name to the module, password management, audio volume, buffer and communication port.

System Settings

Device Name

System Password

Retype System Password

Audio Volume (0-31)
25

Buffer seconds (5-50)
10

Gmt Offset
1

Tunnel Port (requires reboot)
54000

Save Settings **Save Buffer Setting** **Save System Password**

Device Name: device identifier. It is a character label available to the user to identify the device.

System Password: To protect access to the streamer's web page, you can enable password security by typing a password in this line.

Retype System Password: Repeat the same password to avoid typing errors

Audio Volume: Adjustment of the general output level of the stream module towards the audio input.

Buffer Seconds: Setting the audio buffer size.

Gmt Offset: Selection of the geographical area

Tunnel Port: Setting the data communication port for control software Processor Programmer.

Save Settings: Stores audio volume, GMT offset, and tunnel port settings

Save Buffer Settings: Save the changes to the Buffer, this operation stops the streaming for a few seconds.

Save System Password: Save the changes to the system password, if it is entered it will be asked on the Login page, if the "System password" and "Retype System Password" fields are left empty it will not be asked on the Login page.

5.1.5 System update

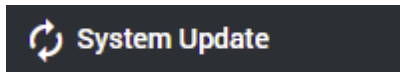

The stream module can be updated via this page.

A screenshot of a web form for system updates. It features a section titled "Upload file" containing a "Scegli file" button and the text "Nessun file selezionato". Below this is a "Do Update" button.

Once you have obtained the upgrade file from the website www.itel.it, to start the update procedure press "Choose File" and search your PC for the downloaded file. Once the selected file name is displayed, press "Do Update" to start the update procedure, wait for the module to restart, after about a minute refresh the page.

5.1.6 Finder software

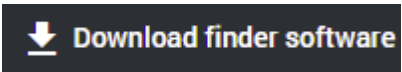

Using the Download Finder Software button you can download the software utility useful for finding the IP address of the stream module. If the module address is unknown, connect the device directly to a PC and use the downloaded utility "IpStream_Finder.exe" to retrieve the IP address.

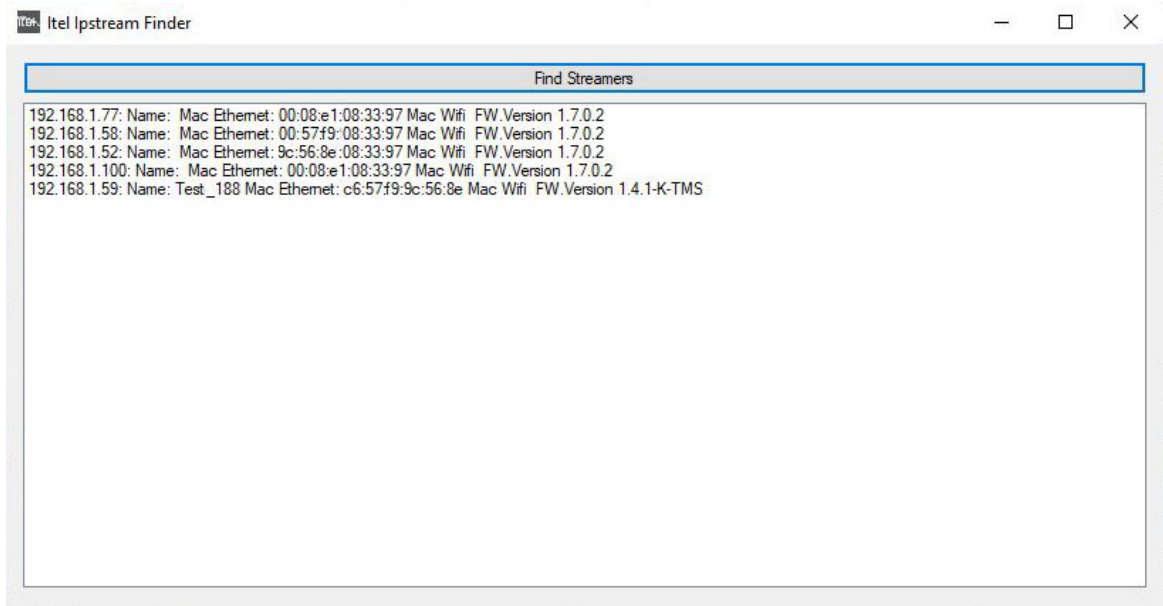

5.2 Encoder audio Sream

The audio streaming encoder module has the task of generating a streaming stream in the IP network, various encoding formats allow the transmission of the audio generated by the processor over the network to shoutcast / icecast servers, even in low latency, using RTP, UDP, Multicast or TCP / IP connectivity.

AvailableCodec:

- MP3 fino a 320kbps, (VBR e CBR),
- PCM 16bit @8, 16, 22.05, 24, 32, 44.1, 48 kHz
- G.711, uLaw, aLaw

An helpful guide for all settings appears on the side of the configuration page.

5.3 Quick setup

The default IP address is **192.168.1.100**.

If the IP is unknown, connect the the processor directly to a PC network card, then use the supplied utility "module_finder.exe" to recover its IP address.

Connect the apparatus to your LAN and turn it on. Open a web browser on a PC from which the apparatus can be reached and type on the web browser's address bar: `http://192.168.1.100`.

The audio module internal webserver should then load the default page.

Go to the "CONFIG" menu and set one or more URLs from which to receive the audio stream.

Save current configuration by pressing the "SAVE & REBOOT" button, wait for the restart of the module.

Configure the network settings of the module: SETUP -> NETWORK

Save by pressing the "SAVE & REBOOT" button, wait for the restart of the module.